

Smart choice for power™

**xantrex™**

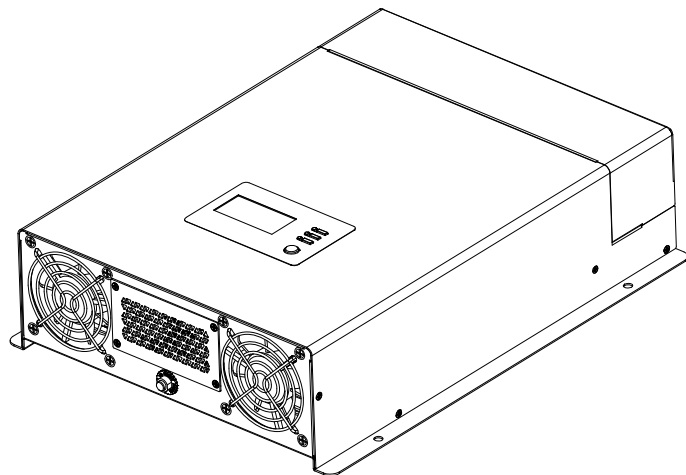

# Freedom XC Series Inverter Charger

**Owner's Guide**

Product Part Numbers  
817-1050  
817-2080



Copyright © 2018 Schneider Electric. All Rights Reserved. All trademarks are owned by Schneider Electric Industries SAS or its affiliated companies.

## Exclusion for Documentation

UNLESS SPECIFICALLY AGREED TO IN WRITING, SELLER

(A) MAKES NO WARRANTY AS TO THE ACCURACY, SUFFICIENCY OR SUITABILITY OF ANY TECHNICAL OR OTHER INFORMATION PROVIDED IN ITS MANUALS OR OTHER DOCUMENTATION;

(B) ASSUMES NO RESPONSIBILITY OR LIABILITY FOR LOSSES, DAMAGES, COSTS OR EXPENSES, WHETHER SPECIAL, DIRECT, INDIRECT, CONSEQUENTIAL OR INCIDENTAL, WHICH MIGHT ARISE OUT OF THE USE OF SUCH INFORMATION. THE USE OF ANY SUCH INFORMATION WILL BE ENTIRELY AT THE USER'S RISK; AND

(C) REMINDS YOU THAT IF THIS MANUAL IS IN ANY LANGUAGE OTHER THAN ENGLISH, ALTHOUGH STEPS HAVE BEEN TAKEN TO MAINTAIN THE ACCURACY OF THE TRANSLATION, THE ACCURACY CANNOT BE GUARANTEED. APPROVED CONTENT IS CONTAINED WITH THE ENGLISH LANGUAGE VERSION WHICH IS POSTED AT [HTTP://WWW.XANTREX.COM](http://www.xantrex.com).

## Document Part Number

975-0784-01-01

## Date and Revision

April 2018 Rev B

## Product Part Number

817-1050 (Freedom XC 1000 120VAC)

817-2080 (Freedom XC 2000 120VAC)

## Contact Information

Telephone: +1 800 670 0707  
+1 408 987 6030

Email: [customerservice@xantrex.com](mailto:customerservice@xantrex.com)

Web: <http://www.xantrex.com>

## Information About Your System

As soon as you open your product, record the following information and be sure to keep your proof of purchase.

Serial Number \_\_\_\_\_

Product Number \_\_\_\_\_

Purchased From \_\_\_\_\_

Purchase Date \_\_\_\_\_

*To view, download, or print the latest revision, visit the website shown under Contact Information.*

# About This Guide

## Purpose

The purpose of this Owner's Guide is to provide explanations and procedures for operating, maintaining, and troubleshooting a Freedom XC Series Inverter Charger for Recreational, Fleet Vehicle, or Marine installations.

## Scope

The Guide provides safety and operating guidelines as well as information on installing and configuring the Inverter. It also provides information about troubleshooting the unit. It does not provide details about particular brands of batteries. You need to consult individual battery manufacturers for this information.

## Audience

The Guide is intended for users and operators as well as installers of the Freedom XC Series Inverter Charger.

## Abbreviation or Acronym

A	Amps
AC	Alternating Current
AGM	Absorbed Glass Mat (a battery type)
DC	Direct Current
in-lb	inch-pound force (a unit of torque)
kW	Kilowatts (1000 watts)
LBCO	Low Battery Cutout (or Cutoff)

LCD	Liquid Crystal Display
LED	Light Emitting Diode
LFP	LiFePO <sub>4</sub> (lithium iron phosphate)
N-m	Newton-meters (a unit of torque)
PPE	Personal Protective Equipment
PV	Photovoltaic (Solar)
V	Volts
VAC	Volts AC
VDC	Volts DC
W	Watts

## Related Information

You can find more information about Xantrex products and services at <http://www.xantrex.com>.

**NOTE:** The Installation section starting on page 9 is intended for qualified personnel. Qualified personnel have training, knowledge, and experience in:

- Installing electrical equipment (up to 1000 volts).
- Applying all applicable installation codes.
- Analyzing and reducing the hazards involved in performing electrical work.
- Selecting and using Personal Protective Equipment (PPE).

# Important Safety Instructions

---

**IMPORTANT:** READ AND SAVE THIS OWNER'S GUIDE FOR FUTURE REFERENCE.

---

This guide contains important safety instructions for the Freedom XC Series Inverter Charger that must be followed during operation and troubleshooting. **Read and keep this Owner's Guide for future reference.**

Read these instructions carefully and look at the equipment to become familiar with the device before trying to install, operate, service or maintain it. The following special messages may appear throughout this bulletin or on the equipment to warn of potential hazards or to call attention to information that clarifies or simplifies a procedure.



The addition of either symbol to a "Danger" or "Warning" safety label indicates that an electrical hazard exists which will result in personal injury if the instructions are not followed.



This is the safety alert symbol. It is used to alert you to potential personal injury hazards. Obey all safety messages that follow this symbol to avoid possible injury or death.

## **DANGER**

**DANGER** indicates an imminently hazardous situation, which, if not avoided, will result in death or serious injury.

## **WARNING**

**WARNING** indicates a potentially hazardous situation, which, if not avoided, can result in death or serious injury.

## **CAUTION**

**CAUTION** indicates a potentially hazardous situation, which, if not avoided, can result in moderate or minor injury.

## **NOTICE**

**NOTICE** indicates a potentially hazardous situation, which, if not avoided, can result in equipment damage.

**Important:** These notes describe things which are important for you to know, however, they are not as serious as a caution or warning.

# Safety Information

1. **Before using the Inverter, read all instructions and cautionary markings on the unit, the batteries, and all appropriate sections of this manual.**
2. Use of accessories not recommended or sold by the manufacturer may result in a risk of fire, electric shock, or injury to persons.
3. The inverter is designed to be connected to your AC and DC electrical systems. The manufacturer recommends that all wiring be done by a certified technician or electrician to ensure adherence to the local and national electrical codes applicable in your jurisdiction.
4. To avoid a risk of fire and electric shock, make sure that existing wiring is in good condition and that wire is not undersized. Do not operate the inverter with damaged or substandard wiring.
5. Do not operate the inverter if it has been damaged in any way.
6. This unit does not have any user-serviceable parts. Do not disassemble the inverter except where noted for connecting wiring and cabling. See your warranty for instructions on obtaining service. Attempting to service the unit yourself may result in a risk of electrical shock or fire. Internal capacitors remain charged after all power is disconnected.
7. To reduce the risk of electrical shock, disconnect both AC and DC power from the inverter before attempting any maintenance or cleaning or working on any components connected to the inverter. Turning the inverter to Standby mode using the Power button on the front panel will not reduce an electrical shock hazard.
8. The inverter must be provided with an equipment-grounding conductor connected to the AC input ground.
9. Do not expose this unit to rain, snow, or liquids of any type. This product is designed for indoor use only. Damp environments will significantly shorten the life of this product and corrosion caused by dampness will not be covered by the product warranty.
10. To reduce the chance of short-circuits, always use insulated tools when installing or working with this equipment.
11. Remove personal metal items such as rings, bracelets, necklaces, and watches when working with electrical equipment.
12. For marine applications, this unit must be installed with a drip shield. Refer to the installation instructions for details.

## DANGER

### **ELECTRICAL SHOCK AND FIRE HAZARD**

Installation must be done by qualified personnel to ensure compliance with all applicable installation and electrical codes and regulations. Instructions for installing the Freedom XC Series Inverter Charger are provided here for use by qualified personnel only.

**Failure to follow these instructions will result in death or serious injury.**

**⚠️⚠️ DANGER**

**HAZARD OF ELECTRIC SHOCK, EXPLOSION, BURN, OR ARC FLASH**

- Apply appropriate personal protective equipment (PPE) and follow safe electrical work practices. See NFPA 70E or CSA Z462.
- This equipment must only be installed and serviced by qualified electrical personnel.
- Never operate energized with the AC compartment cover removed.
- Energized from multiple sources. Before removing the AC compartment cover - identify all sources, de-energize, and wait 2 minutes for circuits to discharge.
- Always use a properly rated voltage sensing device to confirm all circuits are de-energized.
- Replace all devices, doors, and covers before turning on power to this equipment.

**Failure to follow these instructions will result in death or serious injury.**

**⚠️ WARNING**

**ELECTRICAL SHOCK HAZARD**

- Replace the AC compartment cover before turning on power to this equipment.
- Use a torque screwdriver to tighten the captive nut panel screw to 5 in-lb torque to ensure a proper ground connection and a required tool access to the wiring compartment.

**Failure to follow these instructions can result in death or serious injury.**

**⚠️ WARNING**

**FIRE AND EXPLOSION HAZARD**

- Unit's components may produce arcs or sparks.
- Do not install near batteries, in machinery space, or in an area in which ignition-protected equipment is required.

**Failure to follow these instructions can result in death or serious injury.**

Areas include any space containing gasoline-powered machinery, fuel tanks, as well as joints, fittings, or other connections between components of the fuel system.

**⚠ CAUTION**

**ELECTRICAL SHOCK AND FIRE HAZARD**

- Do not open. No serviceable parts inside. Provided with integral protection against overloads. Bonding between conduit connections is not automatic and must be provided as part of the installation.
- Read manual before installing or using.
- Do not cover or obstruct ventilation openings.
- Do not mount in zero-clearance compartment – overheating may result.
- Do not expose to rain or spray. This inverter is designed for marine applications only when additional drip protection is installed in certain orientations. See “Approved Mounting Orientations” on the Installation Guide for more information.
- Install GFCIs only as specified in this manual. Other types may fail to operate.
- Do not connect AC OUT to any other source of power. Damage to unit may occur.
- For AC IN and AC OUT, use wires suitable for at least 75°C.

**Failure to follow these instructions can result in minor or moderate injury.**

**NOTES:**

1. Follow these instructions and those published by the battery manufacturer and the manufacturer of any equipment you intend to use in the vicinity of the battery. Review cautionary markings on these products and on the engine.

2. Freedom XC inverter products are designed for deep cycle lead-acid batteries. See warning below when connecting to lithium ion batteries.
3. Do not use transformerless battery chargers in conjunction with the inverter due to overheating.

**⚠ WARNING**

**LITHIUM\_ION BATTERY TYPE HAZARD**

Make sure to use a lithium ion battery pack that includes a certified Battery Management System (BMS) with built-in safety protocols. Follow the instructions published by the battery manufacturer.

**Failure to follow these instructions can result in property damage, death or serious injury.**

**⚠ CAUTION**

**PHYSICAL INJURY HAZARD**

This Freedom XC Series Inverter Charger is not intended for use by persons (including children) with reduced physical, sensory, or mental capabilities or lack of experience and knowledge, unless they have been given supervision or instruction concerning use of the appliance by a person responsible for their safety. Children should be supervised to ensure that they do not play with the appliance.

**Failure to follow these instructions can result in minor or moderate injury.**



## Precautions When Working With Batteries

**Important:** Battery work and maintenance must be done by qualified personnel knowledgeable about batteries to ensure compliance with battery handling and maintenance safety precautions.

### **WARNING**

#### **BURN FROM HIGH SHORT-CIRCUIT CURRENT, FIRE AND EXPLOSION FROM VENTED GASES HAZARDS**

- Always wear proper, non-absorbent gloves, complete eye protection, and clothing protection. Avoid touching your eyes and wiping your forehead while working near batteries. See note #4.
- Remove all personal metal items, like rings, bracelets, and watches when working with batteries. See notes #5 and #6 below.
- Never smoke or allow a spark or flame near the engine or batteries.

**Failure to follow these instructions can result in death or serious injury.**

#### **NOTES:**

1. Mount and place the Freedom XC Series Inverter Charger unit away from batteries in a well ventilated compartment.
2. Always have someone within range of your voice or close enough to come to your aid when you work near a lead-acid battery.
3. Always have plenty of fresh water and soap nearby in case battery acid contacts skin, clothing, or eyes.
4. If battery acid contacts skin or clothing, wash immediately with soap and water. If acid enters your eye, immediately flood it with running cold water for at least twenty minutes and have someone within range of your voice or close enough to get medical attention immediately.

5. Use extra caution to reduce the risk of dropping a metal tool on the battery. It could spark or short circuit the battery or other electrical parts and could cause an explosion. Use tools with insulated handles only.
6. Batteries can produce a short circuit current high enough to weld a ring or metal bracelet or the like to the battery terminal, causing a severe burn.
7. When removing a battery, always remove the negative terminal from the battery first for systems with grounded negative. If it is grounded positive, remove the positive terminal first. Make sure all loads connected to the battery and all accessories are off so you don't cause an arc.

## Precautions When Placing the Inverter

### **WARNING**

#### **FIRE HAZARD**

Do not install the inverter or any part of its supplied wiring in engine compartments.

**Failure to follow these instructions can result in death or serious injury.**

### **CAUTION**

#### **BURN HAZARD**

Avoid touching the external surfaces - heatsink may be hot.

**Failure to follow these instructions can result in minor or moderate injury.**

### **NOTICE**

#### **RISK OF DAMAGE TO THE INVERTER**

- Never allow battery acid to drip on the inverter when reading gravity, or filling battery.
- Never place the Freedom XC Series Inverter Charger unit directly above batteries; gases from a battery will corrode and damage the inverter.
- Do not place a battery on top of the inverter.

**Failure to follow these instructions can damage the unit and/or equipment.**

## Regulatory

The Freedom XC Series Inverter Charger is certified to appropriate US and Canadian standards. For more information see “Regulatory Approvals” on page 73.

The Freedom XC Series Inverter Charger is intended to be used for mobile or commercial applications. This Inverter is designed for marine applications only when additional drip protection is installed in certain orientations. See the section on Specifications for information.

## FCC Information to the User

This equipment has been tested and found to comply with the limits for a Class B digital device, pursuant to part 15 of the FCC Rules. These limits are designed to provide reasonable protection against harmful interference in a residential installation. This equipment generates, uses, and can radiate radio frequency energy and, if not installed and used in accordance with the instructions, may cause harmful interference to radio communications.

However, there is no guarantee that interference will not occur in a particular installation. If this equipment does cause harmful interference to radio or television reception, which can be determined by turning the equipment off and on, the user is encouraged to try to correct the interference by one or more of the following measures:

- Reorient or relocate the receiving antenna.
- Increase the separation between the equipment and receiver.
- Connect the equipment into an outlet on a circuit different from that to which the receiver is connected.
- Consult the dealer or an experienced radio/TV technician for help.

 <b>CAUTION</b>
Unauthorized changes or modifications to the equipment could void the user's authority to operate the equipment.



# Contents

Important Safety Instructions .....	iii
Introduction .....	1
Features .....	4
Safety Instructions .....	9
Installation Tools and Materials .....	10
Basic Installation Procedures .....	11
Marine Installation .....	36
Inverter and Charger Operation .....	39
Viewing Information During Battery Mode .....	42
Viewing Information During Grid Mode .....	43
Adjusting Feature Settings in Configuration Mode .....	45
Operating in Battery Mode .....	50
Operating in Grid Mode .....	53
Operating During Transition Between Grid Mode and Battery Mode .....	58
Troubleshooting .....	63
Warning Messages .....	64
Troubleshooting Reference .....	66
Inverter Applications .....	70
Specifications .....	71

---

---

# Introduction

The Freedom XC Series Inverter Charger (Freedom XC) is designed with integrated inverting functions and power management features suitable for marine, recreational, and commercial vehicle installations.

Please read this chapter to familiarize yourself with the main performance and protection features of the Freedom XC.

## Materials List

The Freedom XC base package includes the following items:

- one Freedom XC unit
- one Owner's Guide and extra safety labels
- one pre-installed DC ground enclosure lug (not shown)
- one set of plastic bushings for large DC cables<sup>a</sup> (not shown)

**NOTE:** If any of the items are missing, contact Xantrex or any authorized Xantrex dealer for replacement. See “Contact Information” on page i.

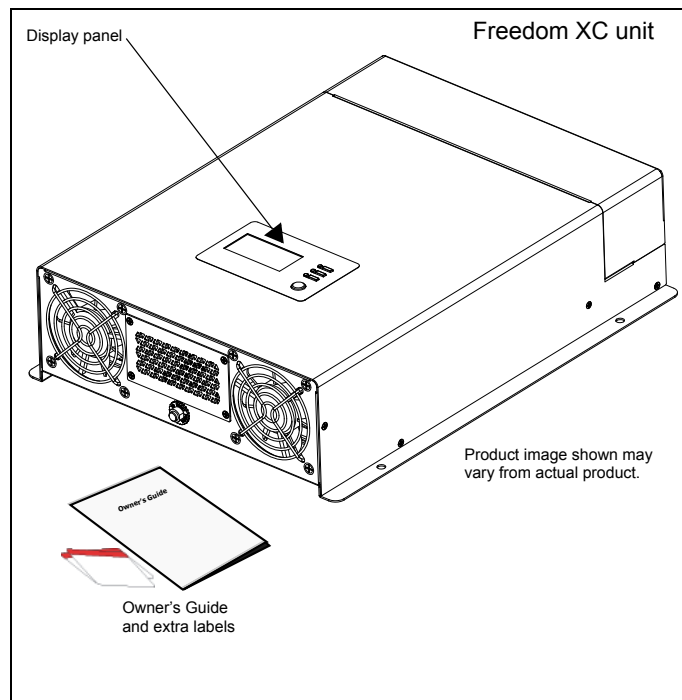

**Figure 1** What's In The Box

<sup>a</sup>. Available only to XC 2000 model.

## Key Features

**Power for Most Appliances** The Freedom XC inverter/charger provides up to 1000 watts (Freedom XC 1000) or 2000 watts<sup>a</sup> (Freedom XC 2000) of continuous utility grade, sine wave power derived from a battery bank. It is designed to handle loads such as microwave ovens, TVs, DVD/Blu-ray players, and power tools. In addition, the Freedom XC's high-surge capability lets you handle many hard-to-start loads, including full size residential refrigerators.

The built-in transfer switch automatically transfers between inverter power and shore power from recreational facilities such as boat docks or campsites to ensure power is always available.

**Back-up Capability** If incoming shore power is interrupted by external events like brownouts, the Freedom XC automatically becomes an independent power source<sup>b</sup> that supplies utility grade AC power to your loads.

**Comprehensive Protection** The Freedom XC's built-in protection features safeguard your batteries (from unnecessary drain) such as the low battery voltage alarm and shutdown and protect equipment such as a configurable AC transfer speed.

- **Selectable Low Battery Shutdown:** The low battery shutdown for the inverter/charger can be manually selected by the user from 10.1 to 12.8 VDC.
- **Low Voltage Shutdown Delay Timer:** Configurable from 1 to 300 seconds to reduce an unnecessary shutdown of inverter operation such as during cranking or other brief but heavy discharge of battery.
- **Inverter Power Save:** The Freedom XC can be programmed to automatically turn off after 1 to 25 hours of continued operation of loads that are under 50 watts. It is designed, with LBCO (low battery cut off), to prevent the battery from deep discharge.

**Configurable AC Transfer Speed** The Freedom XC allows two speed settings for the AC transfer from Grid Mode to Battery Mode and vice versa which avoids nuisance resetting of appliances. The normal transfer rate is for common appliances and the faster transfer rate is designed for more sensitive digital equipment like a desktop computer.

**Overload Alarm and Shutdown** During Battery Mode (also called Inverter Mode), the Freedom XC automatically alerts you if the loads that are connected and drawing power from the unit are close to approaching the maximum operating limit. If so, the Freedom XC automatically shuts down when the maximum operating limit is exceeded. See page 66 for precautions.

---

a. As the temperature on the Freedom XC 2000 rises, it will gradually reduce its continuous power output from 2000 W at 40°C ambient to 1500 W before the over-temperature shutdown occurs at 60°C ambient. See "Specifications" on page 71.

b. Assuming the inverter/charger is connected to a battery source with an adequate charge at the time of the power interruption.



**Over temperature Alarm and Shutdown** During Battery Mode, the Freedom XC automatically alerts you if it is overheating and approaching the over-temperature shutdown limit. The Freedom XC automatically shuts down when the limit is exceeded. See page 66 for precautions.

**Built-in Charge Formulas** For the inverter to perform at the highest level, the batteries must be charged correctly. The Freedom XC has optimized algorithms for flooded, gel, AGM, custom, and lithium iron phosphate [LFP (or LiFePO<sub>4</sub>)] batteries.

**Manual Equalization** Over a period of time, the cells in a flooded battery can develop uneven chemical states. This can result in a weak (undercharged) cell which, in turn, can reduce the overall capacity of the battery. To improve the life and performance of a non-sealed, flooded battery, the Freedom XC multi-stage charging cycle includes a manual equalize mode that can be used, if recommended by the battery manufacturer.

**Dead Battery Charging** Another feature of the Freedom XC is dead battery charging. This is the ability to recharge batteries, even if the battery voltage has reached zero volts.

**Ignition Control** The Freedom XC provides two user-selectable options for ignition control:

- **Ignition Auto-on:** The Freedom XC can automatically turn the inverter on and off in tandem with the vehicle's ignition circuit or a manually operated remote switch.

- **Ignition Lockout:** The Freedom XC features the ability to inhibit the inverter from operating in the absence of a voltage signal from a vehicle's ignition circuit. This is particularly useful if the inverter is required to operate only when a vehicle's engine is running.

**Configurable AC Output Frequency and Voltage** The Freedom XC is factory set to 60 Hz AC output frequency and 120 V AC output voltage. It can be configured to 50 Hz for use in regions outside the USA and Canada. The AC voltage setting can also be configured to either of three settings: 108, 110, or 120 volts.

**Load Management** The Freedom XC has a built-in 30A transfer relay that connects the inverter output or AC input from the AC generator to the loads. Because the usual AC power sources such as small generators often have limited current availability, having the capability to manage your AC loads is extremely valuable. The Freedom XC provides a number of features to facilitate this.

- The charger is power factor corrected to use AC current as efficiently as possible. Minimizing the AC current used by the charger means more current is available for your AC loads.
- The Freedom XC has a power share feature which prioritizes your AC loads by reducing the charge current and maintaining the total input current to less than the breaker setting.

# Features

## AC and DC Panel

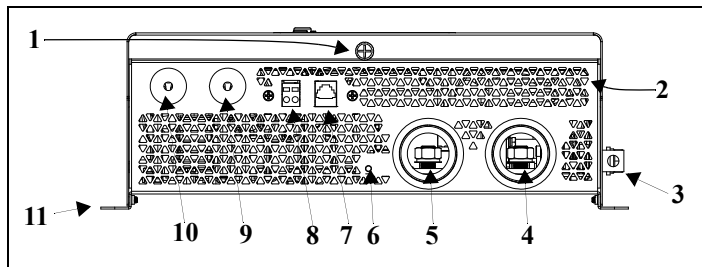

### **⚠ WARNING**

#### **ELECTRICAL SHOCK HAZARD**

Use a torque screwdriver to tighten the captive nut panel screw to 5 in-lb torque of force to ensure a proper ground connection and a required tool access to the wiring compartment.

**Failure to follow these instructions can result in death or serious injury.**

Feature	Description
1	<b>Captive nut panel screw</b> holds the AC compartment cover in place. See WARNING above.
2	<b>Ventilation grille</b> (openings) must not be obstructed.

Feature	Description
3	<b>Grounding stud</b> with attached nut provides a ground path for the Freedom XC chassis to the DC system ground.
4	<b>DC output</b> opening for routing (-) negative DC cable.
5	<b>DC output</b> opening for routing (+) positive DC cable.
6	<b>LED indicator</b> for reverse DC polarity.
7	<b>Remote port</b> allows you to connect an accessory remote control device.
8	<b>ACC input terminal</b> for connecting ignition control wiring. <b>Ignition Control Switch (ACC)</b> for connecting [ON (I)] and disconnecting [OFF (O)] the ignition signal.
9	<b>AC output knockout</b> can be removed for routing AC output wiring.
10	<b>AC input knockout</b> can be removed for routing AC input wiring.
11	<b>Mounting flanges</b> on both sides allow you to mount the inverter/charger permanently on deck or on a wall.

## GFCI Panel

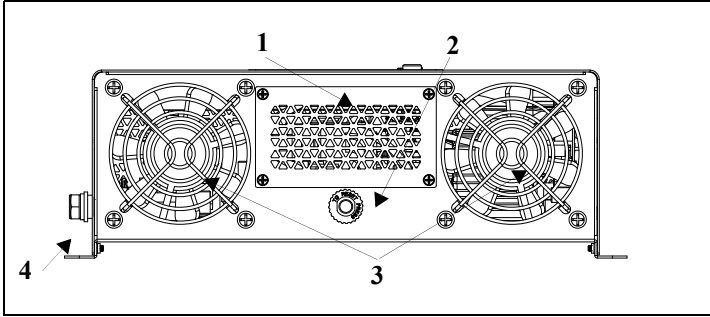

### **⚠ WARNING**

#### **ELECTRICAL SHOCK HAZARD**

Use a torque screwdriver to tighten the bolt on the DC ground lug to a torque of 23 in-lb (2.6 N-m) of force.

**Failure to follow these instructions can result in death or serious injury.**

Feature	Description
1	<b>GFCI cover</b> is removed when installing a qualified GFCI outlet. <b>Location of GFCI receptacles.</b>
2	<b>20 A supplementary protector with reset button</b> provides overload protection for the Freedom XC GFCI kit (PN: 808-9817) option. Press to recover from an overload condition. In a hard wired installation, the supplementary protector does not protect output wiring.
3	<b>Ventilation grille</b> (openings) must not be obstructed for the proper operation of the cooling fan and inverter/charger. When the inverter/charger is mounted, the ventilation grille must not point up or down. <b>Cooling fans</b> turn on when the internal temperature reaches a set point temperature.
4	<b>Grounding lug</b> provides a ground path for the Freedom XC chassis to the DC system ground. See <b>WARNING</b> on the left.

## Display Panel

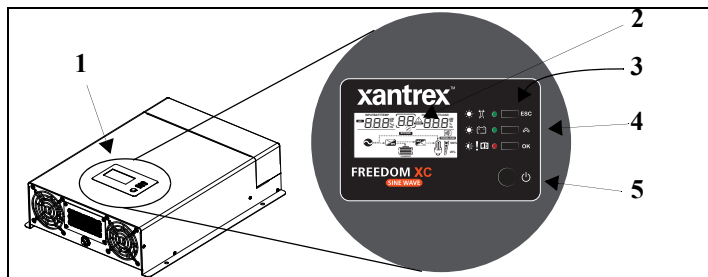

Feature	Description
1	<b>Display panel</b> displays status information on the screen. It is comprised of a display screen, LEDs, select and power buttons.
2	<b>Multi-function LCD screen</b> shows status information and error codes.
3	<b>Status LEDs</b> indicate the mode of operation.
4	Three <b>function buttons</b> change status information displayed on the screen. Also, changes inverter/charger settings.
5	<b>Power button</b> is pressed for turning on the unit. The inverter turns on for the loads and when applicable, the charger turns on automatically.
<b>IMPORTANT:</b> See “Freedom XC Display Panel” on page 39 for detailed information on the panel’s buttons.	

## Side Panel

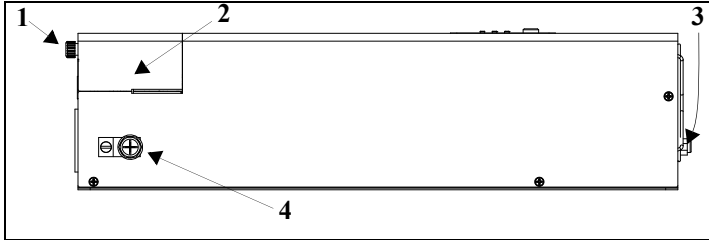

### **⚠ WARNING**

#### **ELECTRICAL SHOCK HAZARD**

Use a torque screwdriver to tighten the captive nut panel screw to 5 in-lb torque to ensure a proper ground connection and a required tool access to the wiring compartment.

Use a torque screwdriver to tighten the bolt on the DC ground lug to a torque of 23 in-lb (2.6 N-m) of force.

**Failure to follow these instructions can result in death or serious injury.**

Feature	Description
1	<b>Captive nut panel screw</b> holds the wiring compartment cover in place.
2	<b>Wiring compartment cover</b> protects the wiring compartment from debris and keeps the cables secure. Using the captive nut panel screw, the cover can be opened and lifted out during wiring. See <b>WARNING</b> on the left.
3	<b>20 A supplementary protector</b> provides overload protection for the GFCI receptacles. In a hard wired installation, the supplementary protector does not protect output wiring.
4	<b>Grounding lug</b> provides a ground path for the Freedom XC chassis to the DC system ground. See <b>WARNING</b> on the left.



# Safety Instructions

## Before You Begin the Installation

Before beginning your installation:

- Read this entire Installation section so you can plan the installation from beginning to end.
- Assemble all the tools and materials you require for the installation.
- Review the Important Safety Instructions on page iii.
- Be aware of all safety and electrical codes which must be met.

### **WARNING**

#### **ELECTRICAL SHOCK AND FIRE HAZARD**

- All wiring should be done by qualified personnel to ensure compliance with all applicable installation codes and regulations.
- Disconnect all AC and DC power sources.
- Disable and secure all AC and DC disconnect devices and automatic generator starting devices.

**Failure to follow these instructions can result in death or serious injury.**

## Installation Codes

Governing installation codes vary depending on the specific location and application of the installation. Some examples include the following:

- The U.S. National Electrical Code (NEC)
- The Canadian Electrical Code (CEC)
- The U.S. Code of Federal Regulations (CFRs)
- Canadian Standards Association (CSA) and the RV Industry Association (RVIA) for installations in RVs
- The American Boat and Yacht Council (ABYC) and US Coast Guard Regulations for Marine installations in the U.S.

It is the installer's responsibility to ensure that all applicable installation requirements are met.

This section for use by qualified personnel only.

# Installation Tools and Materials

You will need the following to install the Freedom XC:

- Wire stripper
- Mounting (#2) screws or bolts
- #2 Phillips torque screwdriver
- 3mm slot long neck screwdriver for spring clamp AC terminals
- Torque wrench for DC terminals (1/2" or 13mm socket wrench)
- AC cable (that is, two-conductor-plus-ground cable), sized appropriately for load and application
- 1/2" Strain relief clamps (for the AC knockouts)
- Wire nuts or crimp connectors for AC wire and appropriate tools
- DC cable, sized appropriately for load and application
- Lugs for DC cables to fit 5/16" DC stud terminals as well as appropriate tools (like a crimping tool)
- AC and DC disconnects and over-current protective devices



# Basic Installation Procedures

This section provides sample installation information as a guide for your installation. For your convenience, the overall procedure is divided into these main steps:

- ❑ Step 1: Designing the Installation on page 12
- ❑ Step 2: Choosing a Location for the Unit on page 17
- ❑ Step 3: Mounting the Unit on page 18
- ❑ Step 4: Connecting the AC Input Wires on page 20
- ❑ Step 5: Connecting AC Output to an Existing AC Circuit on page 24
- ❑ Step 6: Connecting the DC Cables on page 27
- ❑ Step 7: Connecting to a Remote Panel on page 33
- ❑ Step 8: Testing Your Installation on page 34

This section for use by qualified personnel only.

## Step 1: Designing the Installation

Most Freedom XC installations share common components, and some of these are briefly described in Figure 1.

Figure 1 shows some components and their relationship to each other in a typical recreational vehicle or fleet vehicle installation. Also, see “Marine Installation” on page 36.

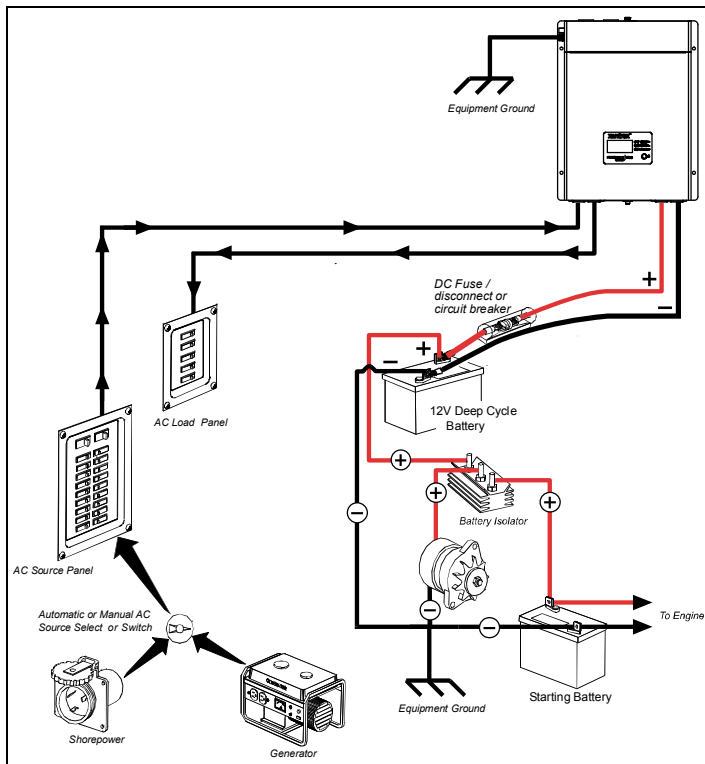

Figure 1 Typical Recreational Vehicle and Fleet Vehicle Installation

## AC Shore Power

A source of 120 volts AC 60Hz sine wave alternating current provides energy to pass power through to AC loads. This source is usually the utility grid (power company) or an AC generator. An automatic or manual AC source selector switch can be used to switch between the multiple sources of shore power to the Freedom XC system.

The AC source feeding the Freedom XC must have the neutral conductor bonded to ground. When the inverter passes shore power through, it will lift its internal bonding relay on the output and will rely on the input being bonded in order to ensure that the power delivered to a sub panel is properly bonded. See “AC Output Neutral Bonding” on page 15 for more information on bonding relay operation.

---

**Important:** Throughout this manual, the term “shore power” refers to AC input power from a utility grid, generator, or other AC source.

## AC Disconnect and Over-Current Protection Device

Most safety requirements and electrical codes require the Freedom XC’s AC and DC inputs and outputs to be provided with over-current protection (such as circuit breakers or fuses) and disconnect devices.

**AC Input:** The circuit breaker or fuse (connected through hard wiring) that is used to supply the Freedom XC must be rated at no more than 30A and must be approved for use on 120 volts AC branch circuits. The wire used between the breaker and the Freedom

XC input must be sized adequately to carry current up to the rating of the input breaker and in accordance with the electrical codes or regulations applicable to your installation.

**AC Output:** The circuit breaker or fuse must be rated at no more than the rating of the input breaker in the installation and must be approved for use on 120 volts AC branch circuits. The wire used between the Freedom XC and the AC output breaker must be of adequate size to match the AC input circuit breaker’s rating. The wiring from each AC output breaker to each of the loads must be adequately sized to carry the current rating of the individual AC output breaker.

**Disconnect Devices:** Each system requires a method of disconnecting the AC circuits. If the over-current protection devices are circuit breakers, they will also serve as the disconnects. If fuses are used, separate AC disconnect switches will be needed ahead of the fuses. These will have to be a branch circuit rated for 120 volts AC and have an appropriate current rating.

This section for use by qualified personnel only.

## AC Distribution Panels

Most systems incorporate distribution centers both ahead of the Freedom XC (the AC source panel) and between the Freedom XC and the loads (the AC load panel). An AC source panel includes a main circuit breaker, which serves as over-current protection and as a disconnect for the AC shore power supply line. Additional circuit breakers serve individual circuits, one of which serves the Freedom XC. The AC load panel can incorporate an AC output circuit breaker and breakers for individual load circuits.

### **NOTICE**

#### **RISK OF DAMAGE TO THE INVERTER**

Do not connect the Freedom XC to a 120/240V, 3-pole, 4-wire circuit.

**Failure to follow these instructions can damage the unit and/or equipment.**

## AC Cabling

AC cabling includes all the wires and connectors between the AC source and the Freedom XC, as well as all cabling between the Freedom XC and the AC output panels, circuit breakers, and loads. The type and size of the wiring varies with the installation and load. For example, in high vibration environments, such as marine or RV applications, wire nuts may not be acceptable, so crimp splices would be required. In other applications, flexible multiple-strand wire may be required. Installation codes usually specify solid or stranded, overall size of the conductors, and type and temperature rating of the insulation around the wire.

AC breakers and fuses must be sized to adequately protect the wiring that is installed on the input and output AC circuits of the Freedom XC. All breakers and wiring must be sized and connected in accordance with the electrical codes or regulations applicable to your installation. Table 1 gives some examples of wiring sizes based on the U.S. National Electrical Code and the Canadian Electrical Code. These examples are based on using a two-conductor-plus-ground cable rated at 75 °C, and assuming an ambient temperature of up to 30 °C. Ensure that your breakers and fuses have suitable temperature ratings for your wiring. Other codes and regulations may also be applicable to your installation.

**Table 1** Required AC Wire Size vs Breaker Rating

Breaker Size (amps)	10A	15A	20A	30A
Minimum Wire Size	14AWG	14AWG	12AWG	10AWG

## AC Output Neutral Bonding

The neutral conductor of the Freedom XC's AC output circuit (that is, AC Output Neutral) is automatically connected to the safety ground during inverter operation. When AC utility power is present this connection is not present, so that the utility neutral (that is, AC Input Neutral) is only connected to utility ground at your source. This conforms to the National Electrical Code (NEC), which requires that separately derived AC sources (such as inverters and generators) have their neutral conductors tied to ground in the same way that the neutral conductor from the utility is tied to ground in only one place. Check the regulations for your specific application to ensure that the installation will comply with the necessary requirements. In other words, the AC Input Neutral and Output Neutral must be isolated from each other.

## AC Grounding

As per UL458 SA29.5, for all permanently connected marine inverters: The Freedom XC should be connected to a grounded, metal, permanent wiring system. Also, make sure that an AC ground wire is connected to the AC ground terminal on the unit. Do not just connect the line and neutral wires.

All connections to the unit should comply with all local codes and ordinances.

## Ground Fault Circuit Interrupters (GFCIs)

A GFCI is a device that de-energizes a circuit when a current to ground exceeds a specified value that is less than that required to blow the circuit breaker. GFCIs are intended to protect people from electric shocks and are usually required in wet or damp locations.

Installations in marine and recreational vehicles require GFCI protection of branch circuits connected to the AC output of the Freedom XC.

The Freedom XC GFCI Device (PN: 808-9817) option is available to use with the Freedom XC inverter unit. The following GFCI will work correctly with the Freedom XC in the inverter's AC output distribution wiring system.

Make	Model
Eaton/Cooper	SGF20W

## DC Cabling

This includes all the cables and connectors between the batteries, the DC disconnect and over-current protection device, and the Freedom XC. Most mobile installations require multi-strand insulated cables for flexibility and durability in high vibration environments and require disconnects and over-current devices. Electrical wiring sizes in North America are indicated by AWG notation. In other parts of the world, the metric system is used.

This section for use by qualified personnel only.

## Basic Installation Procedures

Under the AWG standard, a larger gauge number indicates a smaller wire diameter. Wire size is usually marked on the larger sized cables. Table 2 specifies the minimum recommended DC cable size and maximum fuse size for the Freedom XC. **The DC cables must be copper and must be rated 75 °C minimum.** The cables should be terminated with lugs that fit the DC stud terminals snugly ( $\frac{5}{16}$ " hole size).

**Table 2** Recommended Cable and Fuse Sizes

Inverter	Cable Length: Battery to Inverter (one way)	Minimum Cable Size	Maximum battery Fuse Size
Freedom XC 1000 120VAC	Less than 5 feet (1.5 meters)	No. 2 AWG	150 A DC
Freedom XC 2000 120VAC	Less than 5 feet (1.5 meters)	No. 2/0 AWG	250 A DC

**NOTE:** It is not recommended using a cable longer than 5 feet (1.5 meters) in each direction. North American cable sizes above are based on the US National Electrical Code Table 310.17 - 75 °C cables, assuming an ambient temperature of 30 °C cables.

**Important:** Using the correct cable size is critical to achieving the rated performance of the Freedom XC unit. When starting a heavy load the Freedom XC can draw current surges from the battery of up to 400A. If the DC wiring is too small the voltage drop from this surge will result in a voltage at the Freedom XC terminals that is too low for the Freedom XC to operate correctly. The Freedom XC may appear to operate correctly with smaller cables until a heavy load such as a microwave or refrigerator attempts to start - then the unit may work correctly sometimes and not work correctly other times.

## DC Disconnects and Over-Current Devices

The DC circuit from the battery to the Freedom XC must be equipped with a disconnect and over-current device. This usually consists of a circuit breaker, a “fused-disconnect”, or a separate fuse and DC disconnect. **Do not confuse AC circuit breakers with DC circuit breakers.** They are not interchangeable. The rating of the fuse or breaker must be matched to the size of cables used in accordance with the applicable installation codes. The breaker or disconnect and fuse should be located as close as possible to the battery, in the positive cable. Applicable codes may limit how far the protection can be from the battery.

## Batteries

The Freedom XC uses 12-volt battery banks. Every Freedom XC system is recommended to have a deep-cycle battery or group of batteries with a total capacity of 100 Ah or more which provides the DC current that the Freedom XC converts to AC.

## Step 2: Choosing a Location for the Unit

### **WARNING**

#### **FIRE AND EXPLOSION HAZARDS**

- Do not install the Freedom XC in compartments containing batteries or flammable materials, or in locations that require ignition-protected equipment. This includes any space containing gasoline-powered machinery, fuel tanks, or joints, fittings, or other connections between components of the fuel system. This equipment contains components that tend to produce arcs or sparks.
- Do not cover or obstruct the ventilation openings. Do not install the Freedom XC in a zero-clearance compartment. Overheating may result.

**Failure to follow these instructions can result in death or serious injury.**

The Freedom XC should only be installed in locations that meet the following requirements:

- Dry.** Do not allow water or other fluids to drip or splash on the Freedom XC. **Do not mount the Freedom XC in an area subject to splashing water or bilge water.**
- Cool.** Normal air temperature should be between -4 °F and 104 °F (-20 °C and 40 °C)—the cooler the better.
- Ventilated.** Allow at least 5 inches of clearance at the DC end of the Freedom XC for air flow, 1 inch on each side, and 2

inches at the AC end. The more clearance for ventilation around the unit, the better the performance. Do not allow the ventilation openings on the ends of the unit to become obstructed.

- Safe.** Do not install the Freedom XC in the same compartment as batteries or in any compartment capable of storing flammable liquids like gasoline.
- Close to the battery compartment and the AC source and load panels.** Avoid excessive cable lengths (which reduce input and output power due to wire resistance). Use the recommended cable lengths and sizes, especially between the battery banks and the Freedom XC.
- Protected from battery acid and gases.** Never allow battery acid to drip on the Freedom XC or its wiring when reading specific gravity or filling the battery. Also do not mount the unit where it will be exposed to gases produced by the batteries. These gases are very corrosive, and prolonged exposure will damage the Freedom XC.

This section for use by qualified personnel only.

## Step 3: Mounting the Unit

### To mount the Freedom XC:

1. Remove the Freedom XC from its shipping container, verify that all components are present, and record relevant product information on “Information About Your System” in the Owner’s Guide.
2. Select an appropriate mounting location and orientation. (See Figure 2 below.) To meet regulatory requirements, for use in on-land applications, the Freedom XC must be mounted in one of the following orientations:
  - Under a horizontal surface (see A)
  - In a horizontal position on a vertical surface (see B)

**NOTE:** For marine installations, only this orientation is allowed, due to the probability of moisture finding access into the enclosure.

- On a horizontal surface (see C)

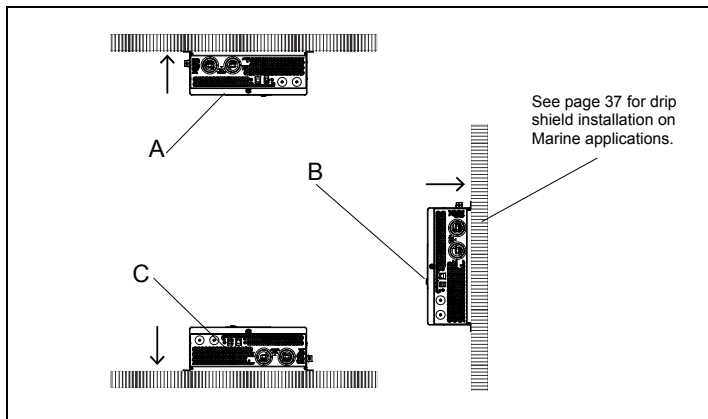

**Figure 2** Approved Mounting Orientations

3. Mark the desired number of mounting holes on the wall by placing the unit on the wall.
4. Pilot-drill the mounting holes.
5. Fasten the Freedom XC to the mounting surface. If you are mounting the unit on a wall or bulkhead, use #12 or #14 pan-head wood or sheet metal screws to secure it to the framing behind the wall or bulkhead. Alternatively, use nut inserts and 1/4"-20 machine screws.



## Connecting the Equipment Ground

### **⚠ WARNING**

#### **SHOCK AND ENERGY HAZARD**

Never operate the Freedom XC without properly connecting the equipment ground. A shock and energy hazard could result from improper grounding.

**Failure to follow these instructions can result in death or serious injury.**

The Freedom XC has a ground lug on the side of the unit as shown in Figure 3. Follow the guidelines in “Grounding Locations” to connect the inverter’s chassis to the ground.

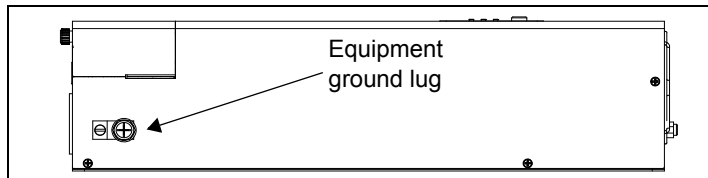

**Figure 3** DC Panel Connections

## Grounding Locations

You must connect the equipment ground lug to a grounding point—usually the vehicle’s chassis or DC negative bus ground—using recommended copper wire (if insulated then green insulation with or without one or more yellow stripes) or larger.

Make sure to tighten the bolt on the DC ground lug to a torque of 23 in-lb (2.6 N-m) of force.

For recommended equipment ground cable size, see below.

**Table 3** Recommended Equipment Ground Cable size

<b>Application</b>	<b>Minimum equipment ground cable size (Stranded copper cable is required)</b>
Recreational Vehicle <sup>a</sup>	No. 8 AWG
Marine <sup>b</sup>	No. 3 AWG (Freedom XC 1000) No. 1/0 AWG (Freedom XC 2000)

**NOTE:** There are no restrictions on length for the equipment ground cable.

a. Based on US National Electrical Code NFPA70, Article 551, par. 551-20c.

b. Based on ABYC E-11 § 11.16 and A-31 § 31.6.5.

In general, the equipment ground cable size must not be smaller than one AWG size than the supply cable.

This section for use by qualified personnel only.

## Step 4: Connecting the AC Input Wires

 **WARNING**

**FIRE, SHOCK, AND ENERGY HAZARDS**

Make sure wiring is disconnected from all electrical sources before handling. All wiring must be done in accordance with local and national electrical wiring codes. Do not connect the output terminals of the Freedom XC to any incoming AC source.

**Failure to follow these instructions can result in death or serious injury.**

### General AC Wiring Considerations

**AC Wiring Connectors** Where applicable, connect AC wires with crimp-on splice connectors. The amount of insulation you strip off individual wires will be specified by the connector manufacturer and is different for different types of connectors.

**AC and DC Wiring Separation** Do not mix AC and DC wiring in the same conduit or panel. Where DC and AC wires must cross, make sure they do so at 90° to one another. Consult applicable codes for details about DC and AC wiring in close proximity to each other.

AC wiring includes all the wires and connectors between the AC source and the Freedom XC and all wiring between the inverter, the AC panels, and circuit breakers. The type and size of the wiring varies with the installation and load. For some RV applications, flexible multiple-strand wire is required.

AC wiring must be sized appropriately to carry full load current on the input and output AC circuits in accordance with the electrical codes or regulations applicable to your installation. Table 4 is based on the U.S. National Electrical Code and the Canadian Electrical Code, assuming two-conductor-plus-ground cable, using 75 °C wiring, at an ambient temperature of 30 °C. Other codes and regulations may be applicable to your installation.

**Table 4** Required AC wire size vs. required breaker rating

	Required Breaker Size (amps)	Required Wire Size
<b>Freedom XC (both models)</b>	30 A maximum 20 A maximum through a GFCI	10 AWG

The AC input terminal is located inside the unit through the front panel's knockout hole and is labeled properly as **AC IN** or **AC INPUT**. The unit comes with spring clamp-type terminals where individual wires can be attached securely.

**NOTICE****EQUIPMENT DAMAGE**

Make sure the wires are connected properly. The AC wiring terminal blocks are split into input and output sections.

**Failure to follow these instructions can damage the unit and/or equipment.**

When making the AC input and AC output connections, observe the correct color code for the appropriate AC wire, as described below in Table 5.

**Table 5** Color codes for typical AC wiring

Color	AC Wire
Black/Red/Brown	Line
White/light blue	Neutral

**Table 5** Color codes for typical AC wiring

Color	AC Wire
Green, green/yellow, or bare copper	Ground (Earth)

**NOTICE****REVERSE POLARITY DAMAGE**

Make sure the wires are connected properly. Improper connections (connecting a line conductor to a neutral conductor, for example) will cause the Freedom XC to malfunction and may permanently damage the inverter. Damage caused by a reverse polarity connection is not covered by your warranty.

**Failure to follow these instructions can damage the unit and/or equipment.**

**Wiring Knockouts** When installing wires to AC terminals, always remove the appropriate wiring knockouts (there are two on the AC panel) and install the proper strain-relief clamps or bushings.

This section for use by qualified personnel only.

## AC Input Connections

1. Ensure AC and DC power sources are turned off.
2. Install the required circuit breaker in the AC distribution panel supplying AC power to the unit.
3. Remove the AC compartment cover by loosening the captive nut panel screw and lifting the cover up and out.

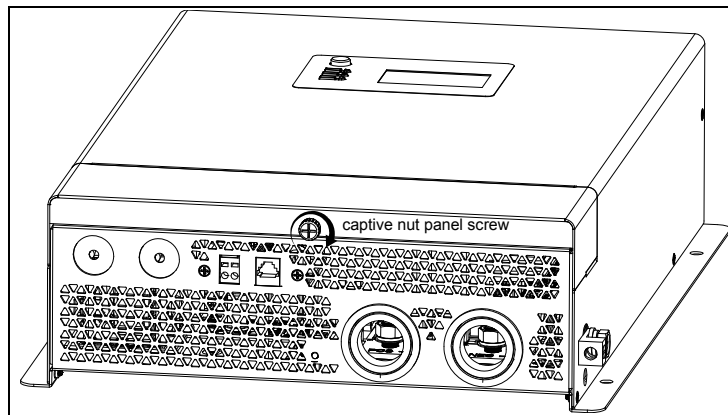

4. Strip a single AC input wire, as appropriate. Strip 10 mm off the ends of each of the three the wires (tin the exposed copper wire with lead-free solder using a soldering iron).
5. Remove the knockout and install a ½" strain relief clamp.

6. Route the wires through the strain relief clamp (not shown in the figure).

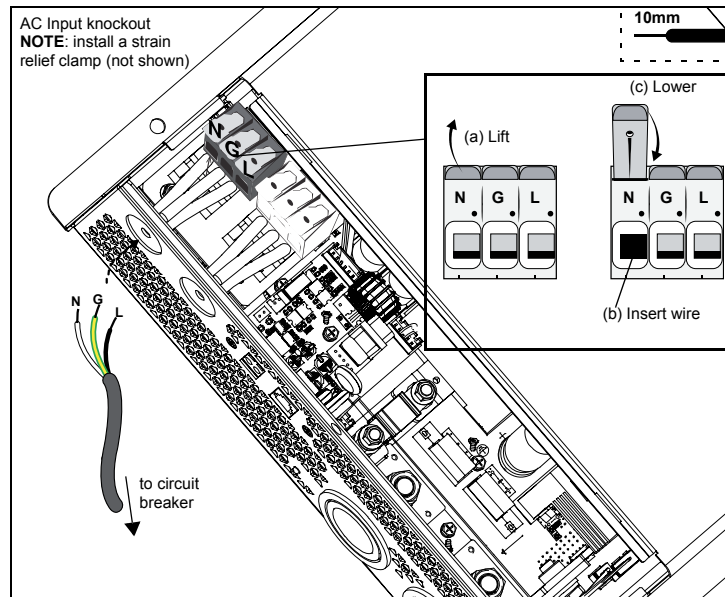

7. Locate the Neutral, Ground and Line terminals on the AC input terminal labeled as **N**, **G**, and **L** respectively.

8. Connect each AC wire into its corresponding terminal on the no-tool cage clamp terminal block.
  - (a) Lift the terminal lever (as shown in the previous figure).
  - (b) Insert the wire fully into the open slot.
  - (c) Lower the terminal lever to secure the wire in the slot.
9. Make sure that each AC wire is matched and connected to the Neutral (**N**), Ground (**G**), and Line (**L**) connections.

Alternatively, the AC connections may come with a tool release cage clamp terminal block. If this is the case, instead of a terminal lever in 8(a), you may use a 3mm slot long neck screwdriver and insert it into a rectangular slot to hold open the cage clamp. And instead of lowering the terminal lever in 8(c), you may remove the 3mm slot long neck screwdriver from the rectangular slot to close the cage clamp and secure the wire.

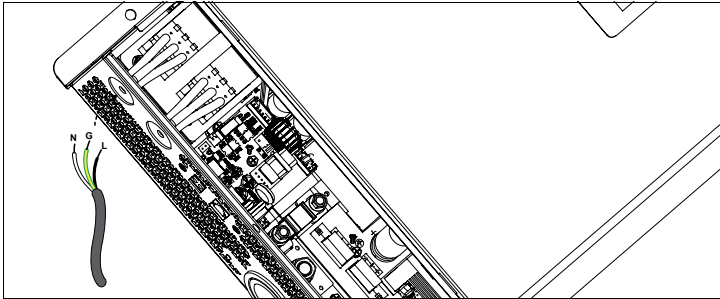

10. Tighten the strain relief clamp to secure the wires.

11. Replace the AC compartment cover onto the unit (using a #2 Phillips torque screwdriver - see WARNING), if you are not connecting other wires such as for the AC Output. Otherwise, keep the AC compartment open and proceed to the next step.
12. Connect the other end of the wires to the circuit breaker in the AC distribution panel supplying AC power to the unit.

**⚠ WARNING**

**ELECTRICAL SHOCK HAZARD**

Use a torque screwdriver to tighten the captive nut panel screw to 5 in-lb torque to ensure a proper ground connection and a required tool access to the wiring compartment.

**Failure to follow these instructions can result in death or serious injury.**

This section for use by qualified personnel only.

## Step 5: Connecting AC Output to an Existing AC Circuit

**⚠ WARNING**

**FIRE, SHOCK, AND ENERGY HAZARDS**

Make sure wiring is disconnected from all electrical sources before handling. All wiring must be done in accordance with local and national electrical wiring codes.

**Failure to follow these instructions can result in death or serious injury.**

A manufacturer-tested and approved GFCI must be connected to the Freedom XC AC output, and GFCI protection must be provided on every receptacle connected to the AC hard wired installation. Other types may fail to operate properly when connected to the Freedom XC. See “” on page 16.

**NOTICE**

**EQUIPMENT DAMAGE**

Do not connect any AC source (such as a generator or utility power) to the AC output wiring of the Freedom XC.

The Freedom XC will not operate if its output is connected to AC voltage from another source, and potentially hazardous or damaging conditions may occur. These conditions can occur even if the inverter is off.

**Failure to follow these instructions can damage the unit and/or equipment.**

Do not connect the Freedom XC to an AC branch circuit that has high-power consumption loads.

The Freedom XC will not operate electric heaters, air conditioners, stoves, and other electrical appliances that consume more than its rated watts.

## AC Output Connections

To make a permanent connection to existing AC wiring:

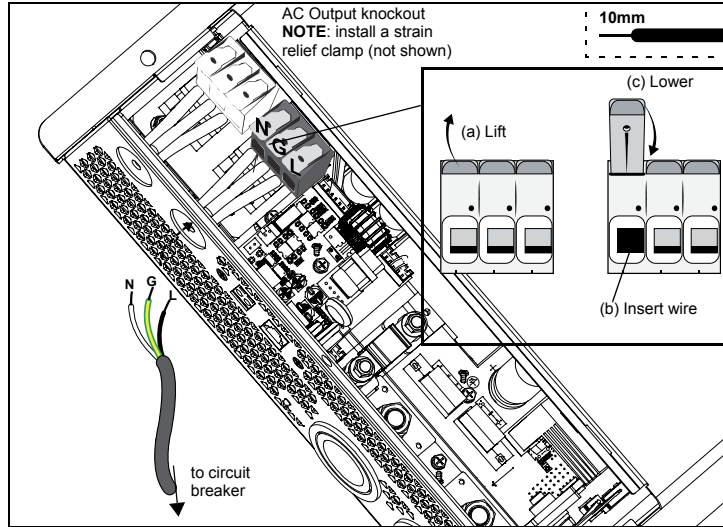

1. Ensure AC and DC power sources are turned off, if not already done from “Step 4: Connecting the AC Input Wires” on page 20.
2. Install the required circuit breaker in the inverter distribution panel receiving AC power from the inverter.
3. Remove the AC compartment cover, if not already done from “Step 4: Connecting the AC Input Wires” on page 20.

4. Strip a single AC output wire, as appropriate. Strip 10 mm off the ends of each of the three the wires (tin the exposed copper wire with lead-free solder using a soldering iron).
5. Remove the knockout and install a ½" strain relief clamp.
6. Route the wires through the strain relief clamp (not shown in the figure).
7. Connect each AC wire into its corresponding terminal on the no-tool cage clamp terminal block.
  - (a) Lift the terminal lever (as shown on the left).
  - (b) Insert the wire fully into the open slot.
  - (c) Lower the terminal lever to secure the wire in the slot.
8. Make sure that each AC wire is matched and connected to the Neutral (**N**), Ground (**G**), and Line (**L**) connections.

Alternatively, the AC connections may come with a tool release cage clamp terminal block. If this is the case, instead of a terminal lever in 8(a), you may use a 3mm slot long neck screwdriver and insert it into a rectangular slot to hold open the cage clamp. And instead of lowering the terminal lever in 8(c), you may remove the 3mm slot long neck screwdriver from the rectangular slot to close the cage clamp and secure the wire.

This section for use by qualified personnel only.

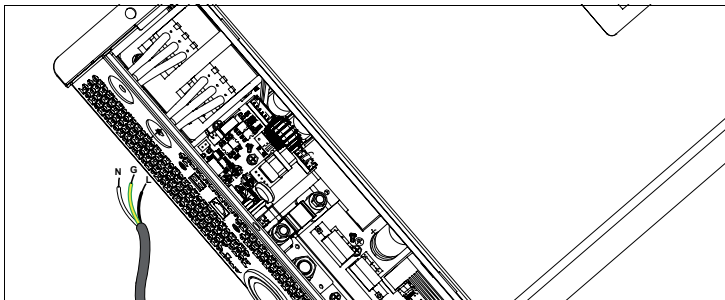

9. Tighten the strain relief clamp to secure the wires.
10. Replace the AC compartment cover (using a #2 Phillips torque screwdriver - see WARNING), if you are finished with connecting all the AC wires in the unit (and installing the GFCI).

### **⚠ WARNING**

#### **ELECTRICAL SHOCK HAZARD**

Use a torque screwdriver to tighten the captive nut panel screw to 5 in-lb torque to ensure a proper ground connection and a required tool access to the wiring compartment.

**Failure to follow these instructions can result in death or serious injury.**

11. Connect the other end of the wires to a circuit breaker in the inverter distribution panel.



## Step 6: Connecting the DC Cables

### NOTICE

#### REVERSE POLARITY DAMAGE

Check cable polarity at both the battery and the Freedom XC before making the final DC connection. Positive must be connected to positive; negative must be connected to negative. Check to see if the reverse polarity LED (see Figure 4) is not illuminated.

Reversing the positive and negative battery cables will damage the Freedom XC and void your warranty.

**Failure to follow these instructions can damage the unit and/or equipment.**

### ⚠ WARNING

#### FIRE HAZARD

Use only copper wire rated 75 °C minimum. Make sure all DC connections are tight to a torque of 71–80 in-lb (8–9Nm) of force. Loose connections will overheat.

**Failure to follow these instructions can result in death or serious injury.**

Follow the procedure given below to connect the battery leads to the terminals on the DC end. The cables should be as short as possible and large enough to handle the required current, in accordance with the electrical codes or regulations applicable to your installation. Table 2 on page 16 specifies the minimum DC cable size and maximum fuse size for the Freedom XC.

If at all possible, minimize routing your DC cables through an electrical distribution panel, battery isolator, or other device that will cause additional voltage drops which can degrade the inverter's ability to operate the loads.

Figure 4 shows the DC end for your reference. The reverse polarity LED will light up when the DC cables were reversed during installation.

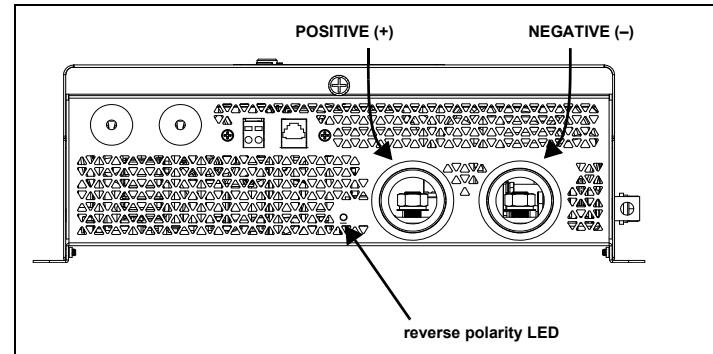

Figure 4 DC End

This section for use by qualified personnel only.

### To make the DC connections

Refer to Figure 5.

1. Make sure the inverter is off and no AC or DC is connected to the unit.
2. Remove the DC compartment cover by loosening the captive nut panel screw.
3. Loosen the DC terminal nuts from the terminal bolts and set them aside for later.
4. Strip  $\frac{1}{2}$ " (13 mm) to  $\frac{3}{4}$ " (19 mm) insulation from one end of each cable. The amount stripped off will depend on the terminals chosen.
5. Attach the connectors that will secure the cables to the battery, to the disconnect/battery selector switch, and the fuse block. The connectors you use must create a permanent, low-resistance connection. It is recommended to use approved and certified cable ring lugs. Use the tool recommended by the terminal manufacturer. Make sure no stray wires protrude from the lug or terminal.  
**NOTE:** You may find it more convenient to have the cable lugs attached by the company that sells you the cable and/or connectors.
6. Strip  $\frac{1}{2}$ " (13 mm) to  $\frac{3}{4}$ " (19 mm) of insulation from each cable end that will be connected to the inverter cable. The amount stripped off will depend on the terminals chosen.
7. Attach the cable ring lug that will join the cable to the inverter DC terminal. Cover the lug stem with heat shrink insulation (see Figure 5) to ensure that the lug does not touch the enclosure.
8. Install a fuse and fuse holder in the cable that will be used for the positive side of the DC circuit. The fuse must:
  - be as close to the battery positive terminal as possible
  - be rated for DC circuits
  - have an Ampere Interrupting Capacity (AIC) that exceeds the short-circuit current available from the battery (that is, Class T fuse)
9. To prevent sparking when making the connection, ensure the disconnect/battery selector switch is off.
10. Route the positive cable through the left side strain relief clamp and attach the cable lug on the positive cable to the positive DC terminal on the inverter.
11. Fasten the DC terminal nut (set aside earlier) to the terminal bolt. Tighten the nut to a torque of 71–80 in-lb (8–9 N-m) of force. Do not overtighten. Make the connection snug enough so the cable lug does not move around on the DC terminal. Center it through the DC knockout hole and do not let it touch the edge. See Figure 5, “DC Cable Connections” on page 29.

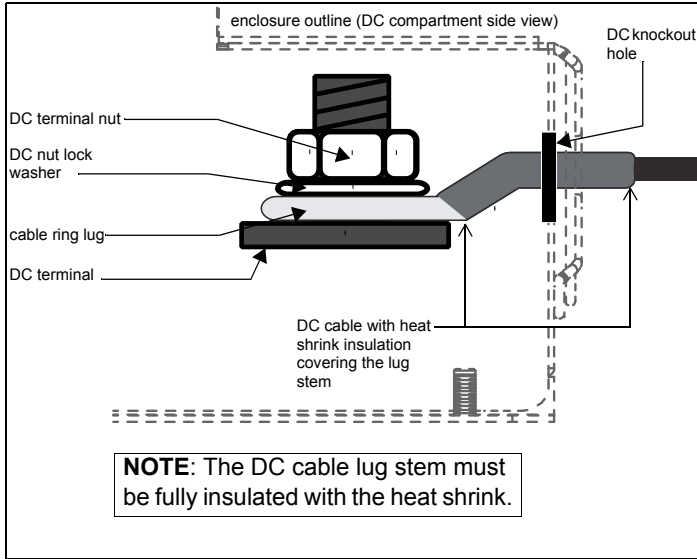

**Figure 5** DC Cable Connections

### **NOTICE**

#### **EQUIPMENT DAMAGE**

Tighten the nuts on terminals properly. Loose connections cause excessive voltage drop and may cause overheated wires and melted insulation.

Do not over-tighten the nut on the DC input terminals. Damage to the DC input terminals may result. The maximum torque setting is **80 in-lb (9 N-m)**.

**Failure to follow these instructions can damage the unit and/or equipment.**

### **NOTICE**

#### **REVERSE POLARITY DAMAGE**

Check cable polarity at both the battery and the Freedom XC before making the final DC connection. Positive must be connected to positive; negative must be connected to negative.

Reversing the positive and negative battery cables will blow a fuse in the Freedom XC and void your warranty.

**Failure to follow these instructions can damage the unit and/or equipment.**

- Before proceeding, double check that the cable you have just installed connects the positive DC terminal of the inverter to the disconnect/battery selector switch, fuse holder, and that the other end of the fuse holder is connected to the positive terminal of the battery.

This section for use by qualified personnel only.

**⚠ WARNING****FIRE HAZARD**

Do not complete the next step if flammable fumes are present. Explosion or fire may result if the disconnect/battery selector switch is not in the off position. Thoroughly ventilate the battery compartment before making this connection.

**Failure to follow these instructions can result in death or serious injury.**

13. Route the negative cable through the right side strain relief clamp and connect the cable from the negative post of the battery to the negative DC terminal of the inverter.
14. Fasten the DC terminal nut (set aside earlier) to the terminal bolt. Tighten the nut to a torque of 71–80 in-lb (8–9 N-m) of force. Do not overtighten. Make the connection snug enough so the cable lug does not move around on the DC terminal. Center it through the DC knockout hole and do not let it touch the edge.
15. Replace the DC compartment cover.

## DC Grounding

### To connect the DC ground:

The equipment grounding lug on the DC end of the Freedom XC is used to connect the chassis of the Freedom XC to your system's DC negative connection or grounding bus point as required by electrical regulations. Use copper wire that is either bare or provided with green insulation. Do not use the DC Ground Lug for your AC grounding. See the AC wiring instructions in this section.

Follow the guidelines below that correspond to the specific type of installation. These guidelines assume you are using the DC supply cable and fuse sizes recommended in this manual. If you are using different sizes, refer to the applicable installation code for DC grounding details.

Make sure to tighten the bolt on the DC ground lug to a torque of 23 in-lb (2.6 N-m) of force.

**Recreational Vehicle** Use 8AWG minimum-sized, stranded copper wire and connect it between the Chassis Ground lug and the vehicle's DC grounding point (usually the vehicle chassis or a dedicated DC ground bus).

**Marine** Use copper wire that is bare or has insulation rated minimum 105 °C, and connect it between the Chassis Ground lug and the boat's DC grounding bus or engine negative bus. For the Freedom XC 1000, use a wire of gauge 3AWG minimum. For the Freedom XC 2000, use a wire of gauge 1/0AWG minimum.

## Connecting to ACC Signal

The Freedom XC can be wired to inhibit inverter operation in the absence of a vehicle's (or vessel's) ignition control signal. This feature can avoid unnecessary battery drain that would otherwise occur if the inverter was operated without a charging source such as the vehicle alternator.

### To enable ignition control:

1. Ensure that AC and DC power are both OFF.
2. Ensure the vehicle's ignition is turned to OFF position. It is highly recommended to remove battery power by disconnecting the vehicle's battery cables. Refer to the vehicle's user manual for proper instructions on how to disconnect the battery cables.
3. Locate the vehicle's ignition control wire from the vehicle's ignition circuit. This wire must be fused appropriately at no more than 5 amps. Refer to the vehicle's user manual for guidance.
4. Locate the ACC input (ignition signal input) terminal on the right side of the connector. The left terminal is not used at this time. See Figure 6.

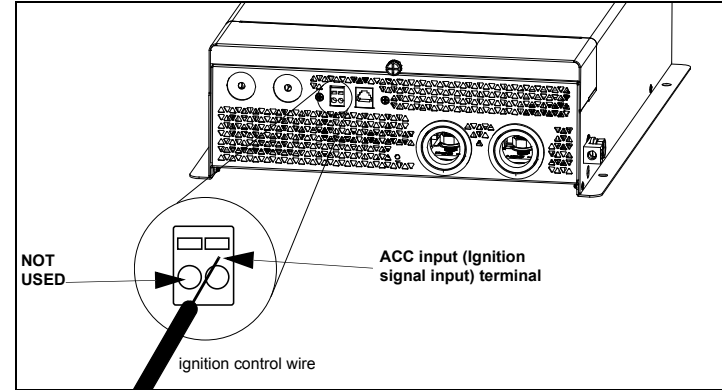

**Figure 6** Ignition Signal (ACC) Input Terminal

5. Using a 3mm slot long neck screwdriver, push into the rectangular slot to release the spring clamp.
6. Insert the ignition control wire into the round ACC input terminal slot.
7. Pull the screwdriver out to engage the spring clamp and secure the wire to the terminal.

This section for use by qualified personnel only.

### Description of Ignition Control Features

For information about the features and instructions on changing the ignition control features, see “Inverter and Charger Operation” on page 39.

Ignition Auto-on ( <b>Auto</b> )	This setting allows the inverter to operate (Battery mode) automatically when an ignition control wire is connected to the ACC input and a valid ignition signal is constantly detected. The inverter works in tandem with the vehicle’s ignition circuit.
Ignition Lock-out ( <b>Lock</b> )	This setting allows the inverter to operate (Battery mode) when an ignition control wire is connected to the ACC input terminal and a valid ignition signal is constantly detected. When enabled, you have to manually press the Power button on the display panel to operate the inverter.
Off ( <b>Off</b> )	To completely disable the ignition control features do the following: 1. Set Ignition Control to Off ( <b>Off</b> ) using the Select buttons on the Display panel.

## Step 7: Connecting to a Remote Panel

### To connect the remote panel:

- ◆ Plug the Freedom X Remote panel (PN: 808-0817) to the RJ12 Remote port on the unit.

---

### NOTE:

When the remote panel is connected, turn the inverter's power button to the Standby mode (up position). This allows the remote panel to control the inverter's power status.

---

## Step 8: Testing Your Installation

**⚠ WARNING**

**ELECTRICAL SHOCK HAZARD**

Pressing the Power button to turn the Freedom XC inverter to Standby mode on the display panel does not disconnect DC or AC input power to the Freedom XC. If shore power is present at AC input terminals, it will pass through to the AC output.

**Failure to follow these instructions can result in death or serious injury.**

There are two tests to be performed. The first test verifies that the Freedom XC is inverting DC battery power and delivering AC power to its output.

The second test is intended for installations where AC input and output is hard wired to the Freedom XC. This test verifies that the Freedom XC transfers from inverter power to shore power when shore power is present.

---

**NOTE:** Shore power (pass-through) refers to the AC input power from a utility grid, generator or external AC source.

---

When you are ready to test your installation and operate the Freedom XC, close the DC fuse and Disconnect or the DC circuit breaker to supply DC power to the Freedom XC.

### Testing in Battery Mode

**To test the Freedom XC in invert mode:**

1. For hard wired installations, ensure shore power is not present.
2. Press the Power button to turn the inverter on.  
The green LED indicating Battery mode (Inverter mode) turns on and the LCD screen displays the **BATT. MODE** icon.
3. Plug a test load, such as a lamp within the power rating of the inverter into the Freedom XC GFCI or an AC outlet hard wired to the Freedom XC.
4. Turn the lamp on to verify that it operates.

If the lamp operates, your installation is successful. If your installation has AC input and output hard wired to the Freedom XC, proceed to “Testing in Grid Mode”.

If the status LED on the display panel glows red, see the Troubleshooting chapter.



---

## Testing in Grid Mode

### To test the Freedom XC in shore power mode:

- ◆ With the test load from the previous test still connected and operating, connect the shore power source.

The Freedom XC transfers the test load to shore power. The green LED indicating grid mode turns on and the LCD screen displays the **AC MODE** icon.

If the test load operates, your installation is successful.

---

**NOTE:** If the Power button on the Freedom XC is turned ON, the Freedom XC will automatically supply the appliances with inverter power if the shore power source fails or becomes disconnected.

If the Power button on the Freedom XC is turned ON and shore power voltage is too low (less than 90 volts AC), the unit will transfer to inverter power to continue running your appliances.

---

**NOTE:** Whether or not the Power button is turned ON, shore power will pass through the Freedom XC to the output when shore power is within normal operating range. The unit also starts charging the battery after the transfer to grid mode.

---

---

**NOTE:** In the event of low or no battery voltage, shore power will pass through the Freedom XC to the output even when shore power is outside the normal operating range.

---

This section for use by qualified personnel only.

# Marine Installation

Figure 7 illustrates a typical marine installation with the following components:

1. AC power supplied from a shore power connector
2. An AC source panel that includes a max 30A (or a 15A if using a GFCI) circuit breaker that supplies the Freedom XC
3. An AC load panel with branch circuit breakers that supply only loads that run off the Freedom XC
4. Engine negative bus / DC ground bus
5. DC power supplied by a battery bank and protected by a DC fuse in the positive cable
6. Battery isolator
7. DC alternator
8. Starting battery
9. Drip shield (see next page)

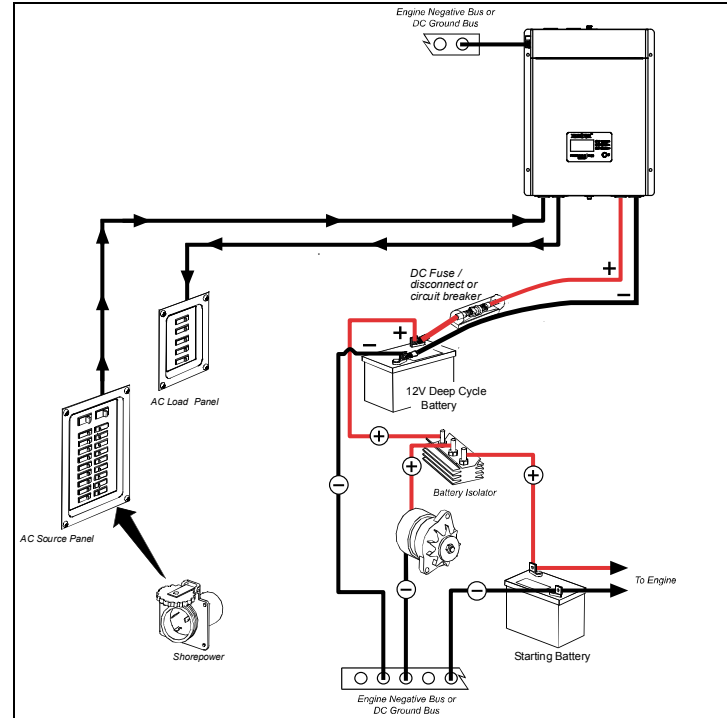

Figure 7 Typical Marine Installation

## Drip Shield Installation

The drip shields help to protect the unit from dripping or splashing liquids, which will cause a shock hazard when moisture comes in contact with electrical circuits in the unit. The drip shields are especially useful in marine installations where water from condensation, rain, or sea may come into contact with the Freedom XC.

### **⚠ WARNING**

#### **ELECTRICAL SHOCK HAZARD**

Place this unit in normally dry areas only. Operating the unit under wet conditions may expose you to a shock hazard. Installing drip shields may not entirely protect you from this hazard. Do not operate the unit when it is wet.

**Failure to follow these instructions can result in death or serious injury.**

You may purchase the drip shield set by contacting customer support. When ordering, mention part number 808-1050.

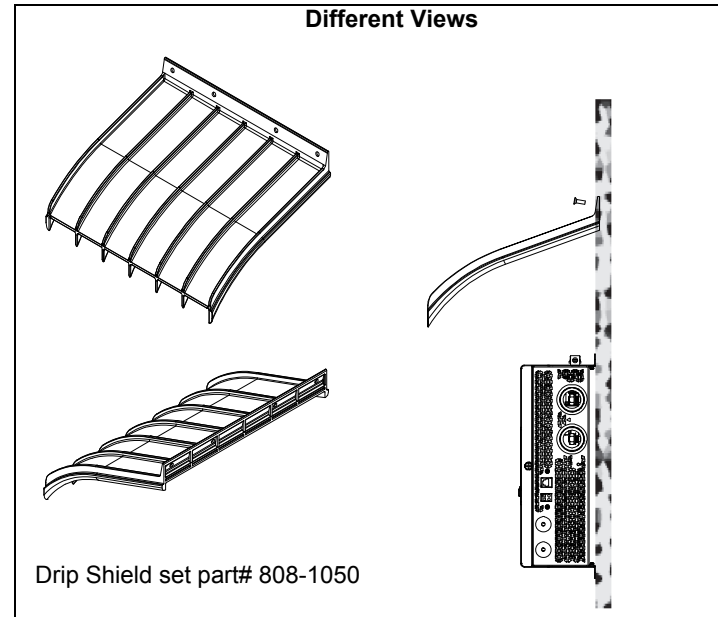
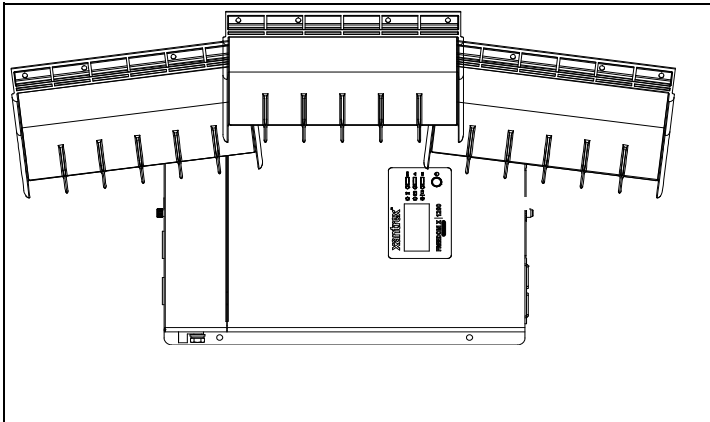

**Figure 8** Drip Shields

This section for use by qualified personnel only.

### To install the drip shields:

1. Gather the four screws needed to fasten a single drip shield to a wall.
2. Locate an appropriate setting for the drip shields above the Freedom XC making sure you cover the entire width of the unit.  
You can overlay the shields as shown in Figure 9 below.
3. Fasten the screws through the holes in the drip shield into the wall. See Figure 8.



**Figure 9** Typical Drip Shield Placement on a Freedom XC 1000

# Inverter and Charger Operation

## Freedom XC Display Panel

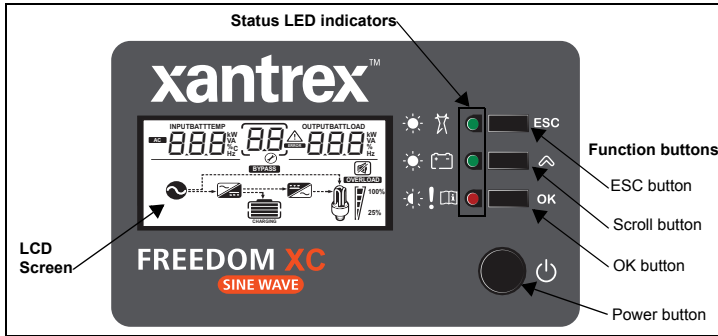



Figure 10 Display Panel

## Status LED Indicators

Indicator	Definition
  <i>solid green</i>	Indicates grid mode in which shore power is available and passing through to the loads and charging the battery.
  <i>solid green</i>	Indicates Battery mode (Inverter mode) in which the inverter is running and supplying power to the loads from the battery.
  <i>solid red</i>	Indicates error or fault mode and is accompanied by an error code displayed on the LCD screen. For a list of error codes, see “Warning Messages” on page 64.
  <i>flashing red</i>	Indicates a Warning condition and is accompanied by an error code and a sounding alarm. For a list of error codes, see “Warning Messages” on page 64.

## Function Buttons

Button	Definition
ESC	return to default screen or exit setting mode
	next screen or next selection
OK	to enter the setting mode or to confirm the setting
	turns on inverter/charger operation or to Standby mode

## LCD Screen

The LCD Screen changes depending on the operating mode of the inverter.

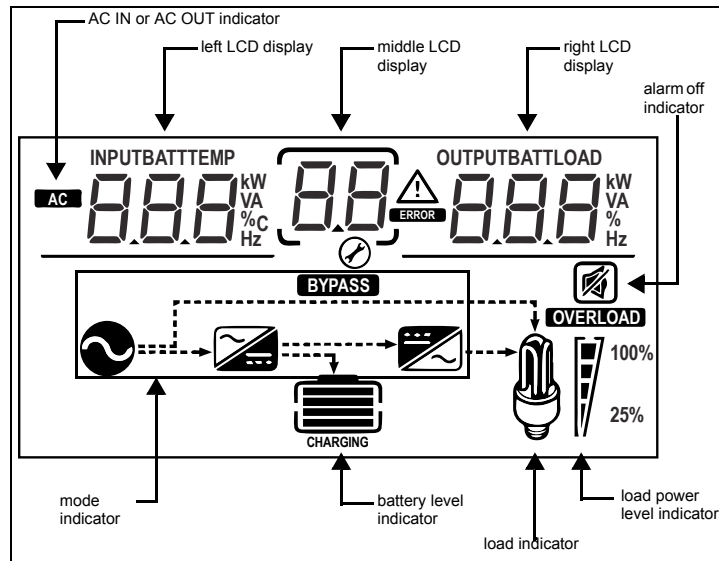





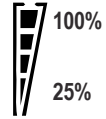





Figure 11 Parts of the LCD Screen

**LCD Screen Icons**

Icon	Definition
	AC input and output indicator.
	The wrench icon underneath a number is displayed during configuration mode.
	An error event with its corresponding number is displayed here.
	A warning event with its corresponding number is displayed here.
<b>CHARGING</b>	The charging indicator is displayed when the unit is in charger mode.
	The battery icon indicates remaining battery power. One bar = 1-25%, two bars = 25-50%, three bars = 50-75%, and four bars = 75-100%.
<b>OVERLOAD</b>	Shows an overload condition.

Icon	Definition
	The load icon is displayed if there is voltage available at the AC output.
	The bar represents load consumption levels. 100% is an indication of full capacity and 25% indicates low consumption. All the bars disappear at < 20 watts, and AC load indicates zero watt power.
	Shows up in grid mode when AC shore power is present. If the power is being qualified, then this icon will flash.
<b>BYPASS</b>	Shows that the unit is in grid mode and is bypassing shore power directly to the loads.
	This icon shows when there is power conversion from AC to DC - charging.
	This icon shows when there is power conversion from DC to AC - inverting.
	The alarm buzzer is muted.

# Viewing Information During Battery Mode

The LCD screen displays information related to battery mode operation.

- ◆ Press the Scroll  button to move from screen to screen.

## Info and Setting LCD Screen

Screen 1 of 4 -  
Battery Voltage/  
Load Wattage

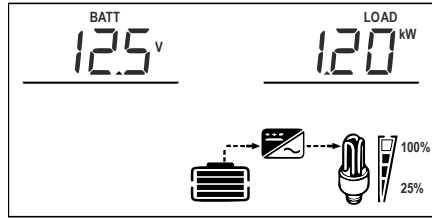

This is the home screen.

battery voltage = 12.5V, AC load = 1.2kW

Screen 2 of 4 -  
AC Output  
Voltage/Frequency

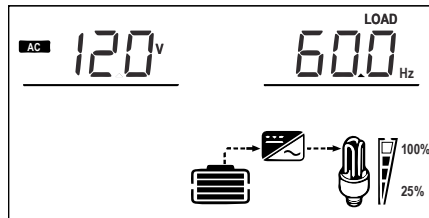

output voltage = 120V, output frequency=60Hz

## Info and Setting LCD Screen

Screen 3 of 4 -  
AC Input Voltage/  
Frequency

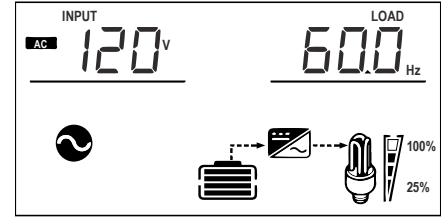

Screen shows up  
when utility AC is  
connected.

input voltage = 120V, input frequency = 60Hz

Screen 4 of 4 -  
Firmware version

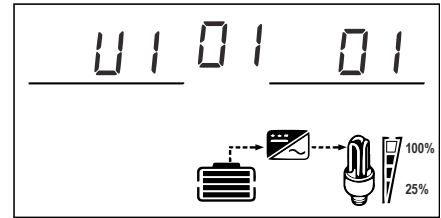

Firmware version = U1 1.01



# Viewing Information During Grid Mode

The LCD screen displays information related to AC bypass or charger operation.

1. Press the Scroll  button to move from screen to screen.
2. Press **ESC** to return to the home screen.

**NOTE:** After one minute of inactivity in the other screens, the LCD will go back to the home screen.

## Info and Setting LCD Screen

Screen 1 of 5 -  
Battery Voltage/  
Charging Stage

This is the home  
screen.

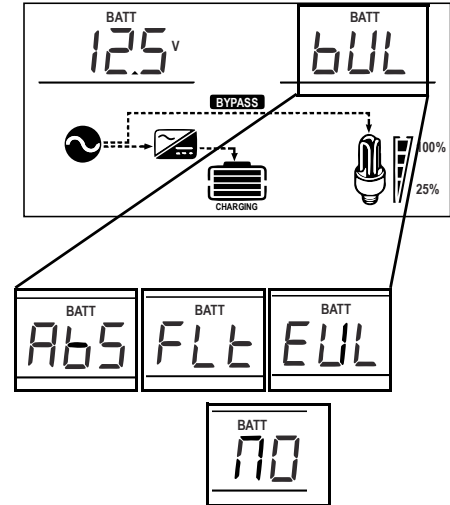

battery voltage = 12.5V, charging stages = bulk, absorption, float, equalization, and no charging

**Info and Setting LCD Screen**

Screen 2 of 5 -  
Battery Voltage/  
Charging Current

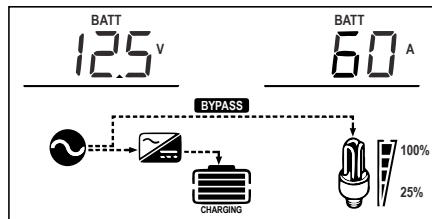

battery voltage = 12.5V, charging current = 60A

Screen 3 of 5 -  
AC input current/  
AC load current

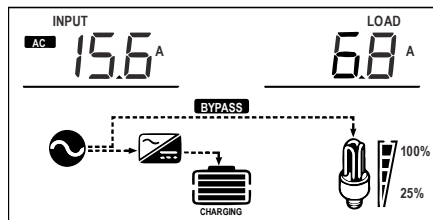

input current = 15.6A, load current = 6.8A

**Info and Setting LCD Screen**

Screen 4 of 5 -  
AC input voltage/  
AC input  
frequency

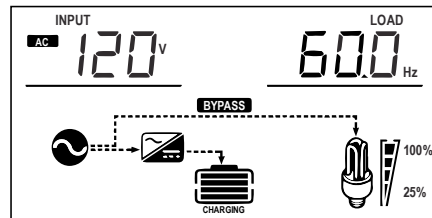

input voltage = 120V, input frequency = 60Hz

Screen 5 of 5 -  
Firmware version

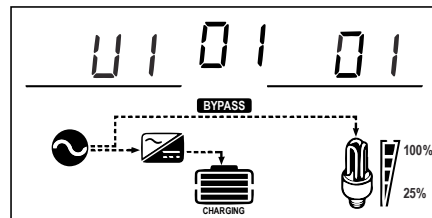

Firmware version = U1 1.01

# Adjusting Feature Settings in Configuration Mode

The **OK**, Scroll , and **ESC** buttons can be used to cycle through the various feature settings:

1. Press and hold the **OK** button for three seconds to enter the feature settings mode.
2. Press the Scroll  button to move through the different feature settings.

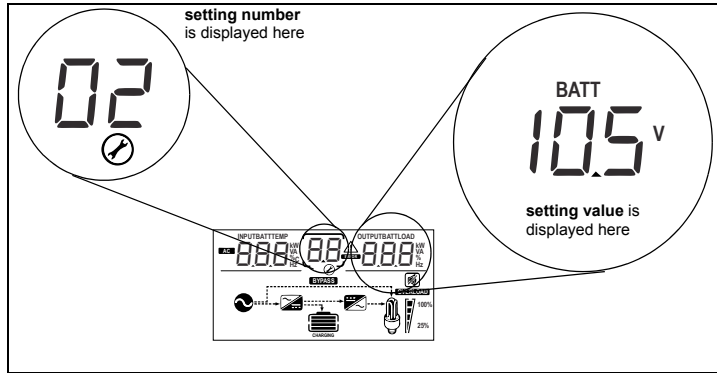

## Settings

Setting Name	Setting Number	Default Value	Range of Values	Description
Inverter Ignition Control	01	OFF	OFF, L0t, A0t	See “Description of Ignition Control Features” on page 32.
LBCO Voltage	02	10.5	10.1 to 12.8	The voltage setting value can be adjusted by 0.1 increments. The inverter is able to recover automatically at LBCO voltage + 0.2 volts.
LBCO Shutdown Delay Timer	03	300	1 to 300	When the range is from 1 to 20, the timer setting value can be adjusted by 1-second increments. When the range is from 20 to 300, the timer setting value can be adjusted by 10-second increments.
LBCO Recovery Voltage	04	13.1	12.0 to 16.0	The range is from LBCO voltage + 0.2 to 16, adjusted by 0.1 increments. Selecting a higher value than the battery’s actual fully-charged voltage level will not activate the auto-recovery feature. You may manually reset the inverter when the low battery cut off event occurs.
Power Save Time	05	25	OFF, 1 to 25	The range is from 1 to 25, adjusted by 1-hour increments. The next setting after 25 is OFF.
Power Save (Load Sensing) Mode	06	d1 5	EnA (enable), d1 5 (disable)	When enabled, the inverter’s “no load” loss can be reduced further when total load is less than 25 watts.
Output Frequency	07	60	60, 50	After changing the output frequency setting, turn the unit off and then on again, in order for the change to take effect.
Output Voltage	08	120	120, 110, 108	



Setting Name	Setting Number	Default Value	Range of Values	Description
Inverter Output Power Limit (Freedom XC 1000)	09	1.0	0.1 to 1.0	The wattage setting value can be adjusted by 100-watt increments. Use with Inverter Output Power Limit Timer especially when pairing with a lithium ion battery. 0.1 is equivalent to 100 watts.
Inverter Output Power Limit (Freedom XC 2000)	09	2.0	0.1 to 2.0	
Inverter Output Power Limit Timer	10	300	1 to 300, OFF	When the range is from 1 to 20, the timer setting value can be adjusted by 1-second increments. When the range is from 20 to 300, the timer setting value can be adjusted by 10-second increments. Use with Inverter Output Power especially when pairing with a lithium ion battery. The timer is automatically disabled if the maximum Inverter Output Power limit is selected.
Transfer Mode	11	A <sub>PL</sub>	A <sub>PL</sub> (appliance), U <sub>PS</sub> (UPS)	Selecting A <sub>PL</sub> - appliance sets the transfer time from line to battery to 20 ms. Selecting U <sub>PS</sub> (uninterruptible power supply) sets the transfer time from line to battery to 10 ms. <b>NOTE:</b> Do not connect motor loads when in UPS transfer mode. See “Troubleshooting” on page 63.
Utility AC Under Voltage Level	12	90	85 to 110	
Inverter Shutdown Recovery	13	A <sub>RE</sub>	A <sub>EO</sub> (auto-restart), A <sub>RE</sub> (manual restart)	The inverter shuts down when there is an over temperature, overload, and short circuit condition. Selecting A <sub>EO</sub> (auto-restart) will allow the inverter to recover automatically from a shutdown up to three times maximum. Selecting A <sub>RE</sub> (manual restart) allows the user to restart the inverter by performing a manual reset, that is, by acknowledging the restart via the display panel.

## Adjusting Feature Settings in Configuration Mode

Setting Name	Setting Number	Default Value	Range of Values	Description
Audible Alarm	14	Off	Off (Audible), Mute	The alarm beeps once every five seconds.
Battery Type	20	FLD	FLD (Flooded), AGM (AGM), GEL (Gel), USE (Custom) LFP (LiFePO <sub>4</sub> )	The use of LFP (LiFePO <sub>4</sub> ) as a battery type requires a compatible BMS. See page vi for safety warning instructions.
Battery Temperature	21	Hot	Cold (Cold), Warm (Warm), Hot (Hot)	Selecting Cold from Warm will increase charger voltage by 0.4V. Selecting Cold from Hot will increase charger voltage by 0.8V.
Custom Absorption Voltage	22	14.6	12.0 to 18.0	The voltage setting value can be adjusted by 0.1 increments. Available only when custom battery type is selected.
Custom Float Voltage	23	13.5	12.0 to 18.0	
Charger Current (Freedom XC 2000)	24	80	5 to 80	The current setting value can be adjusted by 5A increments.
Charger Current (Freedom XC 1000)	24	50	5 to 50	
Charger Ignition Control	26	OFF	OFF (OFF), Auto-ON (Auto-ON)	When set to Auto-ON, the charger operates only in tandem with the vehicle's ignition circuit.
Equalize Charging for Flooded Battery	27	Off	Enable (enable), Disable (disable)	This setting is only available when Flooded battery type is selected. It allows only one hour of equalize charging once.
AC Input Breaker for Load Share	28	Off	5 to 30	The load share feature prioritizes the AC load by reducing the charge current in order to maintain the total input current to less than the load share setting.

Setting Name	Setting Number	Default Value	Range of Values	Description
Reset all settings to their default values	99	dEF	ndF (as is), dEF (default)	

**To change the default value to a different value:**

1. Press and hold the **OK** button for three seconds to enter the feature settings mode.
2. Press the Scroll  button to move through the different feature settings.
3. Press the **OK** button to select a setting number and change its value.
4. Press the Scroll  button to change the value until you reach the desired value.
5. Press the **OK** button to confirm the change.
6. Repeat the previous steps to set other feature settings.
7. Press the **ESC** button to exit the feature settings mode.

# Operating in Battery Mode

The Freedom XC is in Battery Mode (also called Inverter Mode) when all the following conditions exist:

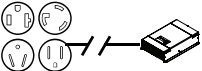
- inverter power button is ON  (down position) or ignition auto-on is activated
- shore power is not presently available 
- battery has sufficient power

Inverter operation means that DC battery power is presently being converted to utility grade AC power, powering equipment and appliances connected to the AC output terminal of the unit.

The green status LED lights up to indicate the Freedom XC is using the battery to power the equipment and appliances.

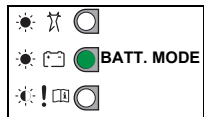

## Turning Inverter Operation ON and OFF

There are two ways to operate the Freedom XC's inverter.

- Press the Power button to a down position (it is in Standby mode in the up position).
- When the inverter's Ignition Control feature is set to Auto-on (AEO)<sup>a</sup>, a +12VDC signal is present<sup>b</sup>.

### **WARNING**

#### **ELECTRICAL SHOCK HAZARD**

Turning the Power button to Standby mode does not disconnect DC battery power from the Freedom XC. You must disconnect both AC and DC power before working on any circuits connected to the unit.

**Failure to follow these instructions can result in death or serious injury.**

To prevent unnecessary battery discharge, press the Power button to Standby mode when you are not using the Freedom XC.

a. See "Adjusting Feature Settings in Configuration Mode" on page 45.

b. When the vehicle's ignition switch is On or the vehicle's engine is running.



## Power Save Timer

The Power Save Timer is an adjustable countdown timer from 1 to 25 hours (25 hours is the default) that automatically shuts down inverter operation to reduce battery discharge and preserve battery life. During continuous inverter operation, the countdown is initiated when power from the AC load drops to less than approximately 50 watts and remains below this level. After reaching the end of the countdown timer the inverter automatically shuts down.

To change the countdown timer, see “To change the default value to a different value:” on page 49.

**Power Save Mode:** By enabling the power save mode, the inverter can automatically go to load sense mode by sending short pulses to further reduce the battery discharge. Power save mode ends when a load greater than 25 W is connected.

## Checking Battery Status

During inverter operation (in battery mode), you can check the battery status by observing the battery capacity indicator on the LCD screen. The battery voltage appears in the left side of LCD screen.

The normal operating battery voltage range is between 11 and 15 volts.

## Checking Output Power

When the inverter is in operation (in battery mode), you can check how much power (displayed in kW) the Freedom XC is supplying to the connected loads by observing the load capacity indicator on the LCD screen. The battery discharge amperage appears in the right side of the LCD screen.

## Operating Several Loads at Once

If you are going to operate several loads from the Freedom XC, turn them on one at a time after you have turned the inverter on.

Turning loads on separately helps to ensure that the inverter does not have to deliver the starting current for all the loads at once, and will help prevent an overload shutdown.

## Turning the Audible Alarm ON or OFF

The Freedom XC's audible alarm can be muted. See “Adjusting Feature Settings in Configuration Mode” on page 45.

Any warnings such as error or fault conditions or imminent shutdown are both displayed on the LCD screen and sounded on the alarm speakers. See “To manually reset the alarm:” below.

Audible alarm for warning: The unit beeps once when a warning condition is detected.

Audible alarm for error: The unit beeps once every five seconds for one minute.

### **To mute the alarm:**

- ◆ Press any one of the three function buttons.

The alarm is automatically muted after one minute. But the error code continues to be displayed until the error is cleared.

### **To manually reset the alarm:**

1. Press the Power button to turn it Off (from a down position to up) and press again to turn it On to reset an active alarm and clear the error or error.
2. If the Inverter Ignition Control is set to auto-on, toggle the ignition signal to clear the alarm and error.
3. Toggle the AC input power to force the transition between grid mode and battery mode. This action clears the alarm and error.

# Operating in Grid Mode

## Battery Charger Functions

When AC power is available, the Freedom XC can operate as a 12-volt battery charger. Different battery types and chemistries require different charging voltage levels. Not charging batteries at the required levels can shorten battery life or damage the batteries. The Freedom XC is configured at the factory to work with the battery types recommended for inverter applications. If the default settings do not work for your specific installation, you can adjust the charge stage settings (as recommended by the battery manufacturer) on the Custom (Battery) Settings menu (see page 57).

---

**NOTE:** This information is provided for guidance only. Variations in battery chemistry and site-specific environmental considerations mean that you should consult your system designer or battery manufacturer for specific recommendations for appropriate battery voltage and current settings.

---

## Battery Types

**Freedom XC** charges flooded (or wet) lead-acid, Gel, AGM (absorbed glass mat), custom, and lithium iron phosphate (LFP) batteries.

- Flooded (or wet) batteries have removable battery caps for refilling with distilled water and testing the electrolyte.
- Gel batteries have the electrolyte in the form of a gel rather than a liquid and do not require topping up. Gel batteries are sealed and the battery caps are not removable.
- AGM (Absorbed Glass Mat) batteries are similar to gel batteries except that the electrolyte is absorbed into a fiberglass matting.
- Custom battery is configured by the dealer, factory, or service center for battery types other than those listed above.
- Lithium iron phosphate (LFP) must only be selected with a lithium iron phosphate battery module with a certified Battery Management System (BMS).

**NOTICE**

**RISK OF BATTERY DAMAGE**

Do not mix battery types. The Freedom XC can only select one battery type setting for all batteries connected to its bank. All connected batteries should either be: Flooded (or wet) *or* Gel *or* AGM *or* Custom *or* LFP.

**Failure to follow these instructions can damage the unit and/or damage other equipment.**

**3-Stage Charging Algorithm**

When enabled, the Freedom XC will charge batteries in a sequence known as three-stage charging. Whenever qualified AC power is present at the inverter’s input, it passes power through to the connected load and begins charging the batteries. The charging voltage delivered to the battery depends on the battery’s:

- Type setting
- Temperature (by switch setting)
- State of charge

The three automatic stages are:

- Bulk
- Absorption
- Float

See Figure 12 for a graph of the three-stage charging profile.

There is a fourth stage, equalization, which is initialized manually as it is only performed occasionally and only on flooded (or wet) batteries.

The charging cycle is a multistage (three-stage) process. Whenever qualified AC power is present at the inverter’s input, it passes power through to the connected load and begins charging the batteries.

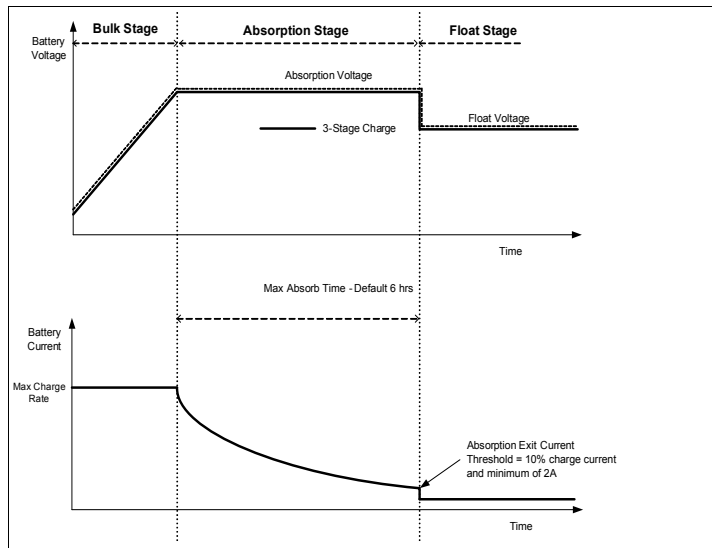

**Figure 12** Three-Stage Battery Charging Cycle

**NOTE:**

When the charge cycle is interrupted, the charger will restart charging at the beginning of the multistage algorithm.

Charge current during equalize state (optional state not shown here) is normally limited to 10A for 60 minutes.

**Bulk Stage**

Bulk charge is the first stage in the charging process and provides the batteries with a controlled, constant current. Once the battery voltage rises to the absorption voltage threshold, the charger switches to the absorption stage.

**Absorption Stage**

During the absorption stage, the Freedom XC begins operating in constant voltage mode and the current falls gradually as the amp hours are returned to the battery.

**Table 6** Preset Absorption Voltage Settings

Battery Type	Preset Absorption Voltage
Flooded	14.0V (Hot), 14.4V (Warm), 14.8V (Cold)
Gel	13.8V (Hot), 14.2V (Warm), 14.6V (Cold)
AGM	14.0V (Hot), 14.3V (Warm), 14.6V (Cold)
Custom Absorption	14.6 (default), changeable between 12.0 to 18.0

The Freedom XC transitions to the float stage if either one of the following two conditions are met:

1. The charge current allowed by the batteries falls below the exit current threshold, which is equal to 10% of the programmed charge current and a minimum of 2A.
2. The Freedom XC has been in absorption for the programmed maximum absorption time limit. The default is 6 hours.

**NOTE:** If there are DC loads on the batteries, the charger’s current may never decrease to a level to initiate the next stage of charging. In this case, the charger would stay in absorption until the Absorb Time setting is reached.

**Float Stage**

Float charge maintains the batteries slightly above the self discharge voltage of the batteries. The charge current in float is the current necessary to maintain the batteries at the Float Voltage setting, limited only by the inverter's capability or other settings that limit the inverter's maximum charge rate. Float charging reduces battery gassing, minimizes watering requirements (for flooded batteries), and makes sure the batteries are in a constant state of readiness. The charger automatically switches to the float stage after the batteries have received a bulk and absorption charge (see Figure 12). The batteries are maintained at the default float voltage level for the selected battery type or the voltage selected under Float Voltage on the Custom Battery Settings menu.

**Table 7** Preset Float Voltage Settings

Battery Type	Preset Float Voltage
	<b>Freedom XC 1000</b>
Flooded	13.5
Gel	13.8
AGM	13.4
Custom Float	13.5 (default), changeable between 12.0 to 18.0

**NOTE:** The battery voltage can increase above the float voltage when using an external charging device such as PV arrays, wind turbines, and micro-hydro generators. Be sure to include appropriate charge management equipment with all external DC sources.

## Equalize Charging

Many battery manufacturers recommend periodic equalize charging to counter cell charge imbalance and capacity-robbing electrolyte stratification. Equalizing helps to improve battery performance and lifespan by encouraging more of the battery material to become active.

Battery equalization is a controlled overcharging method that mixes up stratified electrolyte and reactivates unused areas of the plate material. Periodic equalizing can help to regularly restore batteries to a full and healthy state of charge.

Consult the battery manufacturer's recommendation for equalize charging settings. Sealed batteries should **never** be equalized. Consult the battery manufacturer for optimal charging procedures when using sealed batteries.

When Equalization is enabled, the battery is charged from bulk to absorption, and then to the equalize phase. The Freedom XC will transition from the absorption phase to equalize at an equalize current set to 10 amps.

After absorption, this constant current charge will continue until the voltage has increased to 16 volts DC.

Equalization duration is fixed at one hour.

## Custom Battery Settings Menu

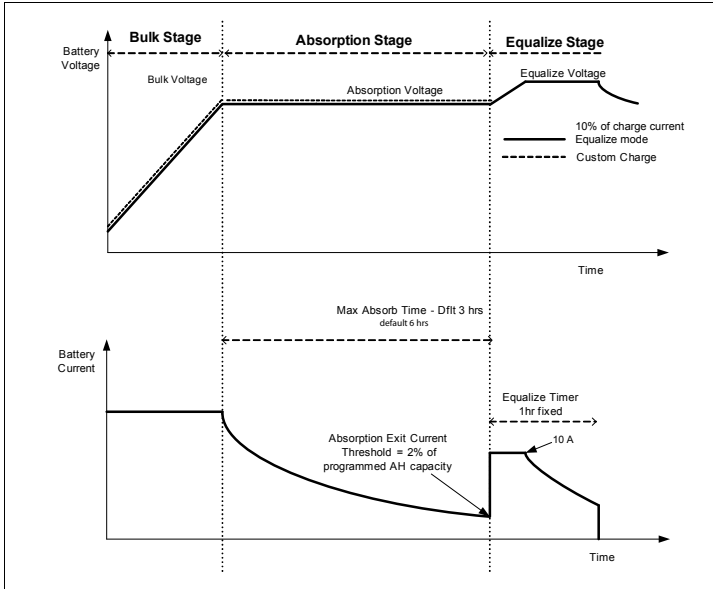

Figure 13 Equalize Charging

### NOTICE

#### EQUIPMENT DAMAGE

To avoid damaging your batteries during charging or equalization, consult your battery manufacturer and associated documentation before setting a custom battery type.

**Failure to follow these instructions can damage the unit and/or damage other equipment.**

Custom battery type can be selected by the setting number 20 (see “Settings” on page 46). After the custom battery is selected, you can then adjust the value of custom absorption (setting number 22) and custom float (setting number 23) accordingly.

# Operating During Transition Between Grid Mode and Battery Mode

The Freedom XC's advanced power management is capable of transitioning power from an AC source to DC source within a fraction of a second and vice-versa.

The Freedom XC automatically detects when shore power is present and when it becomes unavailable or drops to less than 90 volts AC.

The transfer time can be set to two settings. For details see "Adjusting Feature Settings in Configuration Mode" on page 45.

## **NOTICE**

### **EQUIPMENT DAMAGE**

When the transfer mode is set to *UPS*, connect only sensitive digital equipment that requires fast AC transfer times.

Appliances with motors, compressors, and heating elements do not require a transfer mode of *UPS*. Set *RPL* for these devices to avoid damaging the transfer relay.

**Failure to follow these instructions may cause equipment damage.**

## **Transitioning from Grid Mode to Battery Mode**

When the unit is operating in grid mode and shore power is lost, the Freedom XC has less than 20 milliseconds (default) to switch to operating in battery mode (if the Power button is pressed in the On position) and starts drawing power from the battery.

The operating mode indicator will change to Battery Mode and the green Status LED for Battery Mode will light up.

However, if the Power button is in Standby mode, this transition does not happen and the display panel turns off.

## **Transitioning from Battery Mode to Grid Mode**

When the unit is operating in Battery Mode and shore power becomes available, the Freedom XC begins a 20-second countdown to verify the stability of the shore power. If shore power remains stable for a 20-second countdown, at the end of the countdown, the Freedom XC will switch to shore power mode within 20 milliseconds and start drawing power from the AC source.

The operating mode indicator will change to grid mode and the green Status LED for grid mode will light up.



## Operating Limits

### Power Output

The Freedom XC can deliver up to 1000 watts (Freedom XC 1000) and 2000 watts<sup>a</sup> (Freedom XC 2000) of continuous utility grade sine wave AC power. The wattage rating applies to resistive loads such as incandescent lights.

### Input Voltage

The allowable Freedom XC input battery voltage ranges are shown in the following table:

Operating Condition	Battery Voltage	Comment
Full Operating Range	LBCO – 18.0 volts	Assuming the battery is full, the inverter will operate until battery voltage goes past below LBCO <sup>a</sup> and LBCO Shutdown delay timer <sup>b</sup> .
Low Voltage Recovery	< LBCO+0.2 volts	Inverter is able to recover and continue to operate.

a. As the temperature on the Freedom XC 2000 rises, it will gradually reduce its continuous power output from 2000 W at 40°C ambient to 1500 W before the over-temperature shutdown occurs at 60°C ambient. See “Specifications” on page 71.

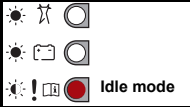
Operating Condition	Battery Voltage	Comment
Low Voltage Shutdown	< LBCO	The buzzer sounds a single one-second low battery alarm beep and the LCD screen shows error code E0 1. After LBCO Shutdown delay timer runs out, the unit shuts down inverter output. The buzzer stops beeping and the LCD screen shows error code E0 1.
Instant Low Voltage Shutdown	< 9.0 volts	After two seconds below the limit, the unit shuts down inverter output completely. LCD screen turns off completely.
High Voltage Shutdown	18.0 volts	The display shows error code E0 2 alternating with the battery voltage. The red status LED turns on.   <p><b>NOTE:</b> Although the Freedom XC incorporates over-voltage protection, it can still be damaged if input voltage exceeds 18.0 volts.</p>

a. To set LBCO, see “Adjusting Feature Settings in Configuration Mode” on page 45.

b. To set LBCO Shutdown Delay Timer, see “Adjusting Feature Settings in Configuration Mode” on page 45.

### Overload Conditions

There are two kinds of overload conditions:

- an overload warning
- an overload shutdown

**Overload Warning** When the Freedom XC's AC load is approximately 100 W below the overload shutdown limit of rated watts, the audible alarm beeps once and the LCD screen shows a error code `E05`.

**Overload Shutdown** When the Freedom XC's AC load increases to near ~1100 W (Freedom XC 1000) and ~2100 W (Freedom XC 2000), the audible alarm beeps every five seconds for one minute and the LCD screen shows a error code `E03`. The Status LED turns solid RED.

### High Surge Loads

Some induction motors used in freezers, pumps, and other motor-operated equipment require high surge currents to start. The Freedom XC may not be able to start some of these motors even though their rated steady state current draw is within the inverter's limits. The unit will shut down and indicate an overload shutdown.

### Over-temperature Conditions

During inverter operation, when the Freedom XC's internal temperature starts to approach its preset shutdown limit, the display will show error code `E07`. If the over-temperature condition persists, the display will show error code `E04`. The Status LED turns solid RED and the inverter will shut down to prevent damage to the inverter and protect the battery from being over-discharged.

## Routine Maintenance

**⚠ WARNING**

**ELECTRICAL SHOCK HAZARD**

Turning off the Power button to Standby mode does not disconnect DC battery power from the Freedom XC. You must disconnect all AC and DC power before working on any circuits connected to the unit.

**Failure to follow these instructions can result in death or serious injury.**

### Freedom XC Unit

Minimal maintenance is required to keep your Freedom XC operating properly. Periodically you should:

- Clean the exterior of the unit with a damp cloth to prevent the accumulation of dust and dirt.
- Ensure that the DC cables are secure and fasteners are tight.
- Make sure the ventilation openings are not clogged.



# Troubleshooting

## **WARNING**

### **ELECTRICAL SHOCK HAZARD**

Do not disassemble the Freedom XC. It does not contain any user-serviceable parts. Attempting to service the unit yourself could result in an electrical shock or burn.

**Failure to follow these instructions can result in death or serious injury.**

**IMPORTANT:** To obtain service go to “Contact Information” on page i.

This section will help you narrow down the source of any problem you encounter. Before contacting customer service, please work through the steps listed below:

1. Check for any error codes displayed on the LCD screen. If a message is displayed, record it before doing anything further.
2. As soon as possible, record the conditions at the time the problem occurred so you can provide details when you contact customer service for help. Include the following information:
  - What loads the Freedom XC was running or attempting to run
  - What the battery condition was at the time (voltage, etc.) if known
  - Recent sequence of events
3. If your Freedom XC is not displaying an error code, check the following to make sure the present state of the installation allows proper operation:
  - Is the inverter located in a clean, dry, adequately ventilated place?
  - Are the battery cables adequately sized as recommended in the Installation guide?
  - Is the battery in good condition?
  - Are all DC connections tight?
  - Are the AC input and output connections and wiring in good condition?
  - Are the configuration settings correct for your particular installation?
  - Are all disconnects and AC breakers closed and operable?
  - Have any of the fuses blown in the installation?
4. Contact customer support for further assistance. Please be prepared to describe details of your system installation and to provide the model and serial number of the unit.

# Warning Messages

Warning messages in the form of audible alarms and error codes that appear on the LCD screen to alert you to an impending system change. Warnings do not affect operation.

With the exception of the error codes displayed on the screen, only the audible alarm can be turned ON or OFF. Follow the steps in “Turning the Audible Alarm ON or OFF” on page 52 to change the alarm settings.

The error codes are listed in Table 8 below. The text in the **Error Code** column appears on the LCD screen of the display panel.

**Table 8** Error Codes Displayed on the LCD Screen

<b>Error Code</b>	<b>Condition</b>	<b>Mode</b>	<b>Action</b>
E01	Low battery voltage shutdown is imminent depending on the setting, see “Operating Limits” on page 59.	Battery mode (inverting)	<ul style="list-style-type: none"><li>• Check battery status and recharge if necessary.</li><li>• Check for proper DC cable sizing.</li><li>• Check for loose connections and tighten if necessary.</li></ul>
E02	High battery voltage shutdown > 18.0 volts DC	Battery mode (inverting)	<ul style="list-style-type: none"><li>• Check for external charging sources, such as a PV charger and an over voltage alternator. Disconnect, if necessary.</li></ul>
E03	AC output overload shutdown	Battery mode (inverting)	<ul style="list-style-type: none"><li>• Reduce the loads connected to the AC outlet of the unit.</li><li>• Check appliances that have high-surge ratings and disconnect if necessary.</li></ul>
E04	Over-temperature shutdown	Battery mode (inverting)	<ul style="list-style-type: none"><li>• Reduce the loads connected to the AC outlet of the unit.</li><li>• Check that the ventilation grille is not blocked.</li><li>• Check for ambient temperature and move the unit to a cooler location whenever possible.</li></ul>

**Table 8** Error Codes Displayed on the LCD Screen

<b>Error Code</b>	<b>Condition</b>	<b>Mode</b>	<b>Action</b>
<i>E06</i>	AC output overload warning	Battery mode (inverting)	<ul style="list-style-type: none"> <li>Reduce the loads connected to the AC outlet of the unit.</li> </ul>
<i>E07</i>	Over-temperature alarm and fan lock alarm	Battery mode (inverting)	<ul style="list-style-type: none"> <li>Reduce the loads connected to the AC outlet of the unit.</li> <li>Check that the ventilation grille is not blocked.</li> <li>Check for ambient temperature and move the unit to a cooler location whenever possible.</li> <li>Check the fan for any obstruction and remove it.</li> </ul>
<i>E08</i>	Fan lock error	Grid mode (bypass)	<ul style="list-style-type: none"> <li>If there is no issue with the fan, disconnect the unit from its DC and AC power sources, then reconnect, and then restart the unit. Perform “Step 8: Testing Your Installation” on page 34.</li> <li>If error detection persists, contact customer service.</li> </ul>
<i>E 10 to E 19</i>	Internal hardware error	Battery and grid modes	<ul style="list-style-type: none"> <li>If error detection persists, contact customer service.</li> </ul>

**For error code *E01*:** after the LBCO shutdown delay, the unit will immediately stop inverting

**For error codes *E02* to *E04*:** the unit will stop inverting

# Troubleshooting Reference

## **WARNING**

### **ELECTRICAL SHOCK HAZARD**

Do not disassemble the Freedom XC. It does not contain any user-serviceable parts. Attempting to service the unit yourself could result in an electrical shock or burn.

**Failure to follow these instructions can result in death or serious injury.**

## **NOTICE**

### **INVERTER DAMAGE**

Avoid continually overloading the inverter and subjecting it to over temperature conditions. Although provided with integral protection against overloads continual overloading can damage the circuitry.

**Failure to follow these instructions can damage the inverter.**

**Table 9** Troubleshooting Reference

<b>Problem</b>	<b>Possible Cause</b>	<b>Solution</b>
Alarm does not sound when an error is encountered.	Alarm is turned OFF.	See “Turning the Audible Alarm ON or OFF” on page 52 and follow instructions to turn the alarm buzzer on again.



**Table 9** Troubleshooting Reference

Problem	Possible Cause	Solution
No output voltage. The status LED is red.	AC shore power is not available or out of operating range and the inverter has shut down with the LCD screen showing one of the following error codes:	
	<ul style="list-style-type: none"> <li>• Low input voltage (error code E01)</li> </ul>	<ul style="list-style-type: none"> <li>• Check the DC connections and the cable.</li> <li>• Recharge the battery.</li> </ul>
	<ul style="list-style-type: none"> <li>• High input voltage (error code E02)</li> </ul>	<ul style="list-style-type: none"> <li>• Verify the unit is connected to a 12V battery.</li> <li>• Check the voltage regulation of the external charging system (if any).</li> </ul>
	<ul style="list-style-type: none"> <li>• Unit overload or AC output short circuit (error code E03)</li> </ul>	<ul style="list-style-type: none"> <li>• Reduce the load. Make sure the load does not exceed the output rating.</li> </ul>
	<ul style="list-style-type: none"> <li>• Thermal shutdown (error code E04)</li> </ul>	<ul style="list-style-type: none"> <li>• Allow the unit to cool off.</li> <li>• Reduce the load if continuous operation is required.</li> <li>• Improve ventilation. Make sure the inverter's ventilation openings are not blocked.</li> </ul>

**Table 9** Troubleshooting Reference

Problem	Possible Cause	Solution
<p>No output voltage is shown in the LCD screen but the green status LED for Battery mode is illuminated.</p>	<p>GFCI (when installed) has tripped or supplementary breaker has tripped.</p> <p>Circuit breaker on the AC load panel or AC output disconnect has tripped.</p> <p>Battery voltage is too low (depending on setting, see “Operating Limits” on page 59) to start inverting. LCD screen may show DC voltage as 000.</p>	<p>Check load and reset the GFCI or supplementary breaker.</p> <p>Reset the circuit breaker or check the AC output disconnect circuits.</p> <p>Check DC connections and cable. Recharge battery.</p>
<p>No output voltage is shown in the LCD screen and neither of the green status LEDs (for Grid mode and Battery mode) is illuminated.</p>	<p>AC shore power is not available or out of operating range and the inverter is OFF.</p> <p>AC shore power is not available and the inverter is OFF due to a shutdown for more than 30 seconds.</p>	<ul style="list-style-type: none"> <li>• Check AC shore power.</li> <li>• Turn the inverter ON.</li> </ul> <ul style="list-style-type: none"> <li>• Check AC shore power and battery voltage.</li> <li>• Turn the inverter ON and look at the LCD screen for any error code.</li> <li>• See Table 8, “Error Codes Displayed on the LCD Screen” on page 64.</li> </ul>
<p>No output voltage. The status LED is not lighting up.</p>	<p>Ignition lock (ACC) signal is not present.</p>	<p>If the ignition control feature is in use, ensure the vehicle’s ignition is On and the ignition control switch on the front of the Freedom XC unit is On ( ).</p>

**Table 9** Troubleshooting Reference

<b>Problem</b>	<b>Possible Cause</b>	<b>Solution</b>
The fan turns on and off during AC shore power mode.	<ul style="list-style-type: none"><li>• The battery is discharged.</li><li>• AC pass-through current is high.</li></ul>	Do not be alarmed, the unit is performing normally.
The fan turns on and off during inverter mode.	The inverter is running continuously at high power.	Do not be alarmed, the unit is performing normally. The fan is activated automatically.

# Inverter Applications

The Freedom XC performs differently depending on the AC loads connected to it. If you are having problems with any of your loads, read this section.

## Resistive Loads

These are the loads that the inverter finds the simplest and most efficient to drive. Voltage and current are in phase (that is, in step with one another). Resistive loads usually generate heat in order to accomplish their tasks. Toasters, coffee pots, and incandescent lights are typical resistive loads. It is usually impractical to run larger resistive loads—such as electric stoves and water heaters—from an inverter due to their high current requirements. Even though the inverter can most likely accommodate the load, the size of battery bank required would be impractical if the load is to be run for long periods.

## Motor Loads

Induction motors (that is, motors without brushes) require two to six times their running current on start up. The most demanding are those that start under load, for example, compressors and pumps. Of the capacitor start motors (typical in drill presses, band saws, etc.), the largest you can expect to run is ½ hp (the transfer relays are rated at 2 hp). Universal motors are generally easier to start. Since motor characteristics vary, only testing will determine whether a specific load can be started and how long it can be run.

If a motor fails to start within a few seconds or loses power after running for a time, it should be turned off. When the inverter attempts to start a load that is greater than it can handle, it will turn itself off after a few seconds.

**Long Transfer Times** The Freedom XC may take a long time (~ 0.1–0.2 seconds) to transfer to Battery Mode when shore power is cut off while powering a motor load. Motor loads typically “freewheel” when power is removed (for example, a grinder) and causes a longer transfer time. The longer transition from shore power to inverter power may cause connected computers or other sensitive equipment to operate incorrectly. To avoid this effect, do not connect motor loads together with sensitive equipment to the inverter for power.

# Specifications

**NOTE:** Specifications are subject to change without prior notice.

Physical Specifications	Freedom XC 1000	Freedom XC 2000
L × W × H	14.2" (360mm) × 10.6" (270mm) × 3.7" (95mm)	15.4" (390mm) × 10.8" (275mm) × 4.0" (102mm)
Net Weight	13.4 lbs (6.1 kg)	16.3 lbs (7.4 kg)

Environmental Specifications	Freedom XC 1000	Freedom XC 2000
Ambient Temperature: Operating Temperature Range <sup>a</sup>	-4 –140 °F (-20 –60 °C), with output derated above 104 °F (40 °C)	-4 –140 °F (-20 –60 °C), with output derated above 104 °F (40 °C)
Storage Temperature Range	-40 –158 °F (-40 –70 °C)	-40 –158 °F (-40 –70 °C)
Humidity: Operation/Storage	5–95% RH, non-condensing	5–95% RH, non-condensing

a. Operation may be limited based on the battery chemistry. For example, Lithium Iron Phosphate batteries have a limited charging temperature range. Follow specific battery manufacturer recommendations for the applicable chemistry.

System Specifications	Freedom XC 1000	Freedom XC 2000
Transfer relay rating	30A surge, 24A continuous	30A surge, 24A continuous
Transfer time (shore to inverter)	<20 milliseconds <sup>a</sup>	<20 milliseconds <sup>a</sup>
Transfer time (inverter to shore)	<20 milliseconds with a 20-second delay	<20 milliseconds with a 20-second delay
Transfer voltage (shore to inverter)	<85 V and >140 V	<85 V and >140 V
Transfer voltage (inverter to shore)	<135 V and >90 V	<135 V and >90 V
Cooling	Fan, activated by any of the following: •High internal temperature •High AC output power	Fan, activated by any of the following: •High internal temperature •High AC output power

a. To change the AC Transfer time (mode), see “Adjusting Feature Settings in Configuration Mode” on page 45.

<b>DC Input (For Inverting)</b>	<b>Freedom XC 1000</b>	<b>Freedom XC 2000</b>
Operating voltage range	LBCO voltage <sup>a</sup> –18.0 VDC	LBCO voltage <sup>a</sup> –18.0 VDC
Maximum non-operating voltage	24 VDC	24 VDC
Nominal voltage	12.0 VDC	12.0 VDC
Nominal current at full load	100 ADC	192 ADC

<b>AC Output (For Inverting)</b>	<b>Freedom XC 1000</b>	<b>Freedom XC 2000</b>
Output voltage options	120, 110, 108 VAC	120, 110, 108 VAC
Continuous power	1000 W <sup>b</sup> @ 40 °C	2000 W <sup>b</sup> @ 40 °C with output derated above 104 °F (40 °C)
Continuous current	8.4 A	16.7 A
Surge power	2000 W	4000 W
Frequency	60 (or 50) Hz <sup>c</sup>	60 (or 50) Hz <sup>c</sup>
Wave shape	True Sine Wave	True Sine Wave
Peak efficiency	91%	91%
Full load efficiency	≥ 87.3%	≥ 87.5%

a. To set LBCO, see “Adjusting Feature Settings in Configuration Mode” on page 45.

b. Power derates to 85% when output voltage is set to 110/108 VAC.

c. To set the AC Frequency, see “Adjusting Feature Settings in Configuration Mode” on page 45.

<b>AC Input (For Charging)</b>	<b>Freedom XC 1000</b>	<b>Freedom XC 2000</b>
Operating voltage range	85–140 VAC	85–140 VAC
Safe non-operating voltage range	up to 240 VAC	up to 240 VAC
Full load maximum current	7 Arms	11 Arms
Nominal frequency	60 (or 50) Hz	60 (or 50) Hz
Power factor at full charge	> 98%	> 98%

<b>DC Output (For Charging)</b>	<b>Freedom XC 1000</b>	<b>Freedom XC 2000</b>
Nominal voltage	12.0 VDC	12.0 VDC
Min battery voltage for charging	0.0 VDC	0.0 VDC
Max output voltage	18.0 VDC (custom battery type)	18.0 VDC (custom battery type)
Nominal output current	User selectable: 5 to 50A <sup>a</sup>	User selectable: 5 to 80A <sup>a</sup>
Charger current derating	May reduce charger current depending on ambient temperature.	May reduce charger current depending on ambient temperature.
Efficiency at nominal output	≥90.1%	≥91%

a. Charger current is rated to 14.4 VDC output only. The charger derates if a high DC output voltage is selected.

<b>Regulatory Approvals</b>	<b>Freedom XC 1000</b>	<b>Freedom XC 2000</b>
Safety	ETL-listed complies to CSA 107.1 UL458 and UL458 Marine Supplement (drip shield with product number 808-1050 required) ABYC E-11, A-31, A-32	ETL-listed complies to CSA 107.1 UL458 and UL458 Marine Supplement (drip shield with product number 808-1050 required) ABYC E-11, A-31, A-32
EMC	CFR47, FCC, Part 15, Subpart B, Class B CAN ICES-3(B)/NMB-3(B)	CFR47, FCC, Part 15, Subpart B, Class B CAN ICES-3(B)/NMB-3(B)







**Schneider Electric Solar  
Inverters USA Inc.**

+1 800 670 0707

+1 408 987 6030

<http://www.xantrex.com>

975-0784-01-01

Printed in China